

TOP CUT 4™
ADVANCES 2015

WIDIA ™

WIDIA™ Top Cut 4™ • New Generation Indexable Drilling System

The new WIDIA Top Cut 4 (TC4) portfolio is a broad offering for customers looking for a versatile indexable drilling platform.

The newly developed TC4 features improved centring capabilities and inserts with four cutting edges for both pocket seats (central and periphery). This, in combination with the renowned WIDIA grade technology, leads to outstanding flexibility and efficiency.

The TC4 platform offers three easy-to-select grades and two geometries applicable for steel, cast iron, and stainless steel materials. It covers the diameter range from 12–68mm within the standard offering in L/D ratios of 2–5 x D.

TOP CUT 4

One Comprehensive Platform

- Standard diameter range covering 12–68mm in 2 x D, 3 x D, 4 x D, and 5 x D.
- Four real cutting edges each for entire platform.
- Eight insert sizes to cover complete diameter range.

Easy to Apply

- No risk of mixing up inner and outer insert due to clear visual differences.
- Easy-to-change inserts, laser marked with geometries and grades.
- Easy-to-use nomenclature guide enabling the tool body and the related insert selection to avoid order failures.

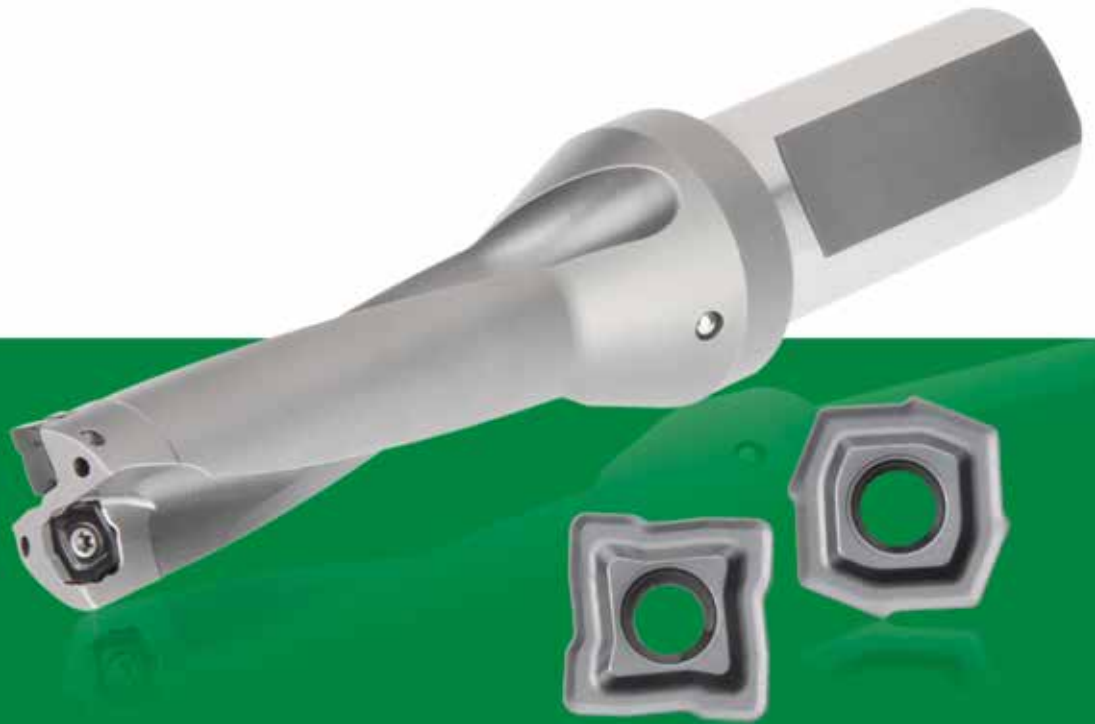

Highly Versatile

- Breadth of application capabilities include through and cross holes, inclined entry and exit opportunity, 45° corner, half cylindrical, concave, or chain drilling.
- Various geometries and grades available.

Highest Performance

- 2x four true cutting edges.
- Cutting edge profile of central and periphery insert work together leading to high stabilization of the drill, preventing drifting of the tool even on irregular surfaces.
- X-offset design to adjust diameter size on turning machines and optimise tolerances on machining centres.
- Apply where speed and economy are prime considerations.
- Three grades to achieve higher tool life at accelerated speeds:
 - WU25CH grade for highest metal removal rate in general applications.
 - WU40PH grade for high toughness demands.
 - WPK10CH grade for high speed applications.

The guide below provides an example of how to select the Top Cut 4 tool body and accompanying inserts for a stable steel drilling application.

Metric Body

TCF	250	R	3	SL	32	M	D
Tool Family Top Cut 4	Diameter Metric = 3 digits (1mm x 10) Inch = 4 digits (1" x 1000)	Right-Hand Cutting	Length Diameter Ratio L/D = 3 x D	Shank Style SL = Side Lock Adaptor	Shank Size	Metric	Insert Size

Periphery Insert

TCF	08	03	08	D	P	V34	WU25CH
Tool Family Top Cut 4	Size In-Circle D1	Insert Thickness	Insert Corner Radius	Insert Size	Insert Positioning C = Central P = Periphery	Insert Geometry	Grade

Insert Geometry – V34 for steel or cast Iron or V36 for stainless steel and long chipping steel.

Insert Guide for Grades

W	U	25	C	H
W	U	40	P	H
W	PK	10	C	H
WIDIA™	Material Range U = Universal P = Steel K = Cast Iron	Toughness Range Choose high numbers for toughness in stable conditions, low numbers for high wear resistance at continuous cuts.	Coating P = PVD C = CVD	Application H = Holemaking

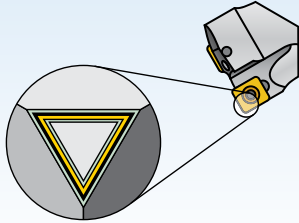

Coatings provide high-speed capability and are engineered for finishing to light roughing.

P	Steel
M	Stainless Steel
K	Cast Iron
N	Non-Ferrous
S	High-Temp Alloys
H	Hardened Materials

Grade	Coating	Grade Description	wear resistance ← → toughness																				
			05	10	15	20	25	30	35	40	45												
WPK10CH		<p>Composition: With an advanced CVD TiCN-Al₂O₃ coating combined with a cobalt-enriched carbide substrate, this grade offers a balanced combination of deformation resistance and edge toughness.</p> <p>Application: Offers outstanding abrasion and crater wear resistance for high-speed machining of steels and cast irons. Use for very high cutting speeds with low to medium feed rates.</p>	P																				
			M																				
			K																				
WU25CH		<p>Composition: Advanced CVD TiCN-Al₂O₃ coating together with a newly engineered tough carbide substrate. Ensures adequate deformation resistance and excellent edge strength and offers very good wear resistance over a wide range of machining conditions.</p> <p>Application: A high productivity grade with high speeds and feeds. First choice for high productivity with very good reliability in steels, stainless steels, and cast iron rates.</p>	P																				
			M																				
			K																				
WU40PH		<p>Composition: With a multilayered PVD TiN-TiAlN coating and a tough substrate, this grade withstands interruptions and provides high wear resistance for long tool life.</p> <p>Application: First choice for high reliability in most materials. This grade should be used at medium speeds and high feeds due to sharper edges and as a grade for high toughness applications. It covers steel, stainless steel, cast iron, and high-temp alloys under certain conditions.</p>	P																				
			M																				
			K																				

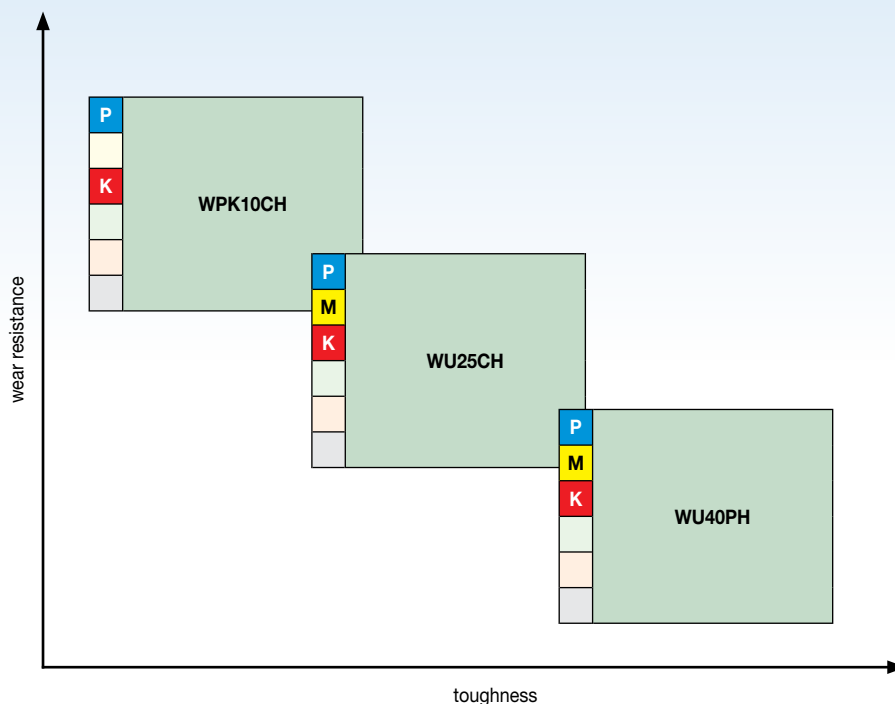

WPK10CH:
High-Speed Grade

WU25CH:
High Metal Removal Rate Grade

WU40PH:
High Toughness Grade

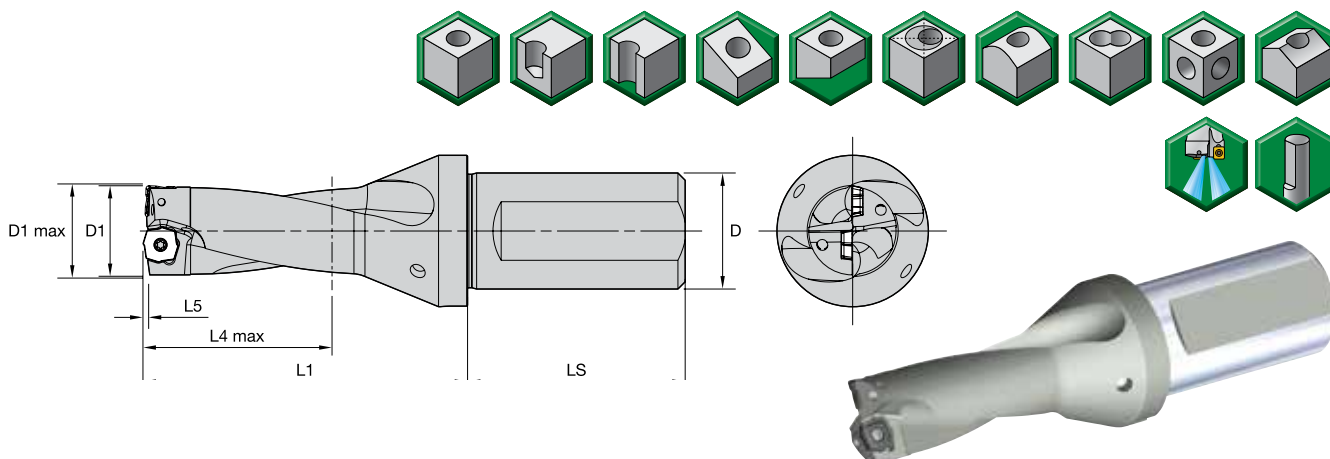

■ Top Cut 4 Drill • Metric • 2 x D • Side Lock Shank

order number	catalogue number	D1	D1 max	D	L1	L4 max	L5	insert size	gage insert outside	gage insert inside
5537778	TCF120R2SL20MA	12,00	13,00	20	54,6	24,0	0,41	A	TCF040204AP	TCF040203AC
5537779	TCF125R2SL20MA	12,50	13,50	20	55,8	25,0	0,48	A	TCF040204AP	TCF040203AC
5537860	TCF127R2SL20MA	12,70	13,70	20	56,2	26,0	0,51	A	TCF040204AP	TCF040203AC
5537861	TCF130R2SL20MA	13,00	14,00	20	56,9	26,0	0,56	A	TCF040204AP	TCF040203AC
5537862	TCF135R2SL20MA	13,50	14,50	20	58,1	27,0	0,64	A	TCF040204AP	TCF040203AC
5577828	TCF140R2SL25MB	14,00	15,00	25	59,8	28,0	0,42	B	TCF050204BP	TCF060203BC
5577829	TCF145R2SL25MB	14,50	15,50	25	60,9	29,0	0,45	B	TCF050204BP	TCF060203BC
5577920	TCF150R2SL25MB	15,00	16,00	25	62,1	30,0	0,49	B	TCF050204BP	TCF060203BC
5577921	TCF155R2SL25MB	15,50	16,50	25	63,3	31,0	0,54	B	TCF050204BP	TCF060203BC
5577922	TCF160R2SL25MB	16,00	17,00	25	64,4	32,0	0,60	B	TCF050204BP	TCF060203BC
5577923	TCF165R2SL25MB	16,50	17,50	25	65,6	33,0	0,68	B	TCF050204BP	TCF060203BC
5577924	TCF170R2SL25MB	17,00	18,00	25	68,4	34,0	0,74	B	TCF050204BP	TCF060203BC
5577925	TCF175R2SL25MB	17,50	18,50	25	69,6	35,0	0,79	B	TCF050204BP	TCF060203BC
5577926	TCF180R2SL25MB	18,00	19,00	25	70,8	36,0	0,86	B	TCF050204BP	TCF060203BC
5577927	TCF185R2SL25MB	18,50	19,50	25	71,9	37,0	0,83	B	TCF050204BP	TCF060203BC
5578820	TCF190R2SL25MC	19,00	20,00	25	72,1	38,0	0,60	C	TCF070306CP	TCF070304CC
5578821	TCF195R2SL25MC	19,50	20,50	25	73,2	39,0	0,70	C	TCF070306CP	TCF070304CC
5578822	TCF200R2SL25MC	20,00	21,00	25	74,4	40,0	0,70	C	TCF070306CP	TCF070304CC
5578823	TCF205R2SL25MC	20,50	21,50	25	75,6	41,0	0,70	C	TCF070306CP	TCF070304CC
5578824	TCF210R2SL25MC	21,00	22,00	25	76,7	42,0	0,80	C	TCF070306CP	TCF070304CC
5578825	TCF220R2SL25MC	22,00	23,00	25	79,0	44,0	1,00	C	TCF070306CP	TCF070304CC
5578826	TCF225R2SL25MC	22,50	23,50	25	80,2	45,0	1,10	C	TCF070306CP	TCF070304CC
5578827	TCF230R2SL25MC	23,00	24,00	25	81,4	46,0	1,10	C	TCF070306CP	TCF070304CC
5537167	TCF240R2SL25MD	24,00	25,00	25	87,2	48,0	0,78	D	TCF080308DP	TCF090305DC
5537168	TCF250R2SL32MD	25,00	26,00	32	89,6	50,0	0,86	D	TCF080308DP	TCF090305DC
5537169	TCF260R2SL32MD	26,00	27,00	32	91,9	52,0	0,97	D	TCF080308DP	TCF090305DC
5537820	TCF265R2SL32MD	26,50	27,50	32	93,0	53,0	1,05	D	TCF080308DP	TCF090305DC
5537821	TCF270R2SL32MD	27,00	28,00	32	94,2	54,0	1,15	D	TCF080308DP	TCF090305DC
5537822	TCF280R2SL32MD	28,00	29,00	32	96,5	56,0	1,30	D	TCF080308DP	TCF090305DC
5537823	TCF290R2SL32MD	29,00	30,00	32	98,8	58,0	1,45	D	TCF080308DP	TCF090305DC
5537937	TCF300R2SL32ME	30,00	31,00	32	100,2	60,0	0,63	E	TCF100408EP	TCF120405EC
5537938	TCF310R2SL32ME	31,00	32,00	32	102,5	62,0	0,72	E	TCF100408EP	TCF120405EC

(continued)

(Top Cut 4 Drill • Metric • 2 x D • Side Lock Shank – continued)

order number	catalogue number	D1	D1 max	D	L1	L4 max	L5	insert size	gage insert outside	gage insert inside
5537939	TCF320R2SL32ME	32,00	33,00	32	104,8	64,0	0,82	E	TCF100408EP	TCF120405EC
5537940	TCF330R2SL40ME	33,00	34,00	40	107,1	66,0	0,95	E	TCF100408EP	TCF120405EC
5537941	TCF340R2SL40ME	34,00	35,00	40	109,4	68,0	1,14	E	TCF100408EP	TCF120405EC
5537942	TCF350R2SL40ME	35,00	36,00	40	111,8	70,0	1,30	E	TCF100408EP	TCF120405EC
5537943	TCF360R2SL40ME	36,00	37,00	40	114,1	72,0	1,45	E	TCF100408EP	TCF120405EC
5578539	TCF370R2SL40MF	37,00	38,00	40	118,1	74,0	1,19	F	TCF120412FP	TCF150406FC
5578600	TCF375R2SL40MF	37,50	38,50	40	119,3	75,0	1,23	F	TCF120412FP	TCF150406FC
5578601	TCF380R2SL40MF	38,00	39,00	40	120,5	76,0	1,27	F	TCF120412FP	TCF150406FC
5578602	TCF390R2SL40MF	39,00	40,00	40	122,8	78,0	1,36	F	TCF120412FP	TCF150406FC
5578603	TCF400R2SL40MF	40,00	41,00	40	125,1	80,0	1,47	F	TCF120412FP	TCF150406FC
5578604	TCF410R2SL40MF	41,00	42,00	40	127,4	82,0	1,60	F	TCF120412FP	TCF150406FC
5578605	TCF420R2SL40MF	42,00	43,00	40	129,7	84,0	1,77	F	TCF120412FP	TCF150406FC
5578606	TCF430R2SL40MF	43,00	44,00	40	132,1	86,0	1,99	F	TCF120412FP	TCF150406FC
5578607	TCF440R2SL40MF	44,00	45,00	40	134,4	88,0	2,10	F	TCF120412FP	TCF150406FC
5578608	TCF450R2SL50MF	45,00	46,00	50	136,7	90,0	2,21	F	TCF120412FP	TCF150406FC
5578694	TCF460R2SL50MG	46,00	47,00	50	139,0	92,0	1,45	G	TCF150512GP	TCF180508GC
5578695	TCF470R2SL50MG	47,00	48,00	50	141,3	94,0	1,53	G	TCF150512GP	TCF180508GC
5578696	TCF480R2SL50MG	48,00	49,00	50	143,7	96,0	1,63	G	TCF150512GP	TCF180508GC
5578697	TCF490R2SL50MG	49,00	50,00	50	146,0	98,0	1,74	G	TCF150512GP	TCF180508GC
5578698	TCF500R2SL50MG	50,00	51,00	50	149,8	100,0	1,87	G	TCF150512GP	TCF180508GC
5578699	TCF505R2SL50MG	50,50	51,50	50	151,0	101,0	1,94	G	TCF150512GP	TCF180508GC
5578710	TCF510R2SL50MG	51,00	52,00	50	152,1	102,0	2,02	G	TCF150512GP	TCF180508GC
5578711	TCF520R2SL50MG	52,00	53,00	50	154,4	104,0	2,22	G	TCF150512GP	TCF180508GC
5578712	TCF530R2SL50MG	53,00	54,00	50	156,8	106,0	2,46	G	TCF150512GP	TCF180508GC
5578713	TCF540R2SL50MG	54,00	55,00	50	159,1	108,0	2,53	G	TCF150512GP	TCF180508GC
5578714	TCF550R2SL50MG	55,00	56,00	50	161,4	110,0	2,73	G	TCF150512GP	TCF180508GC
5578715	TCF560R2SL50MG	56,00	57,00	50	163,7	112,0	2,37	G	TCF150512GP	TCF180508GC
5538613	TCF570R2SL50MH	57,00	58,00	50	165,5	114,0	1,76	H	TCF180614HP	TCF210608HC
5538614	TCF580R2SL50MH	58,00	59,00	50	167,9	116,0	1,85	H	TCF180614HP	TCF210608HC
5538615	TCF590R2SL50MH	59,00	60,00	50	170,2	118,0	1,96	H	TCF180614HP	TCF210608HC
5538616	TCF600R2SL50MH	60,00	61,00	50	172,5	120,0	1,42	H	TCF180614HP	TCF210608HC
5538617	TCF610R2SL50MH	61,00	62,00	50	174,8	122,0	2,23	H	TCF180614HP	TCF210608HC
5538618	TCF620R2SL50MH	62,00	63,00	50	177,1	124,0	2,41	H	TCF180614HP	TCF210608HC
5538619	TCF630R2SL50MH	63,00	64,00	50	179,5	126,0	2,64	H	TCF180614HP	TCF210608HC
5538630	TCF640R2SL50MH	64,00	65,00	50	181,8	128,0	2,94	H	TCF180614HP	TCF210608HC
5538631	TCF650R2SL50MH	65,00	66,00	50	184,1	130,0	3,06	H	TCF180614HP	TCF210608HC
5538632	TCF660R2SL50MH	66,00	67,00	50	186,4	132,0	3,18	H	TCF180614HP	TCF210608HC
5538633	TCF670R2SL50MH	67,00	68,00	50	188,7	134,0	3,30	H	TCF180614HP	TCF210608HC
5538634	TCF680R2SL50MH	68,00	69,00	50	191,1	136,0	2,93	H	TCF180614HP	TCF210608HC

(continued)

(Top Cut 4 Drill • Metric • 2 x D • Side Lock Shank — continued)

■ Spare Parts



insert size	periphery	centre	insert screw	Torx size	Torx driver	tightening torque Nm
A	TCF040204AP	TCF040203AC	12146011800	T5	12146010000	0,40
B	TCF050204BP	TCF060203BC	193.281	T6	170027	0,53
C	TCF070306CP	TCF070304CC	MS1152	T7	12147549000	0,90
D	TCF080308DP	TCF090305DC	192.432	T8	12148086600	1,10
E	TCF100408EP	TCF120405EC	12748610000	T9	170024	2,00
F	TCF120412FP	TCF150406FC	193.332	T15	12148082400	4,00
G	TCF150512GP	TCF180508GC	MS1160	T20	12148007500	6,30
H	TCF180614HP	TCF210608HC	MS1982	T25	1022519	8,80

D	LS
25,00	56
32,00	60
40,00	70
50,00	80

NOTE: Drilling in stacked plates possible in certain applications. Ask for technical support.

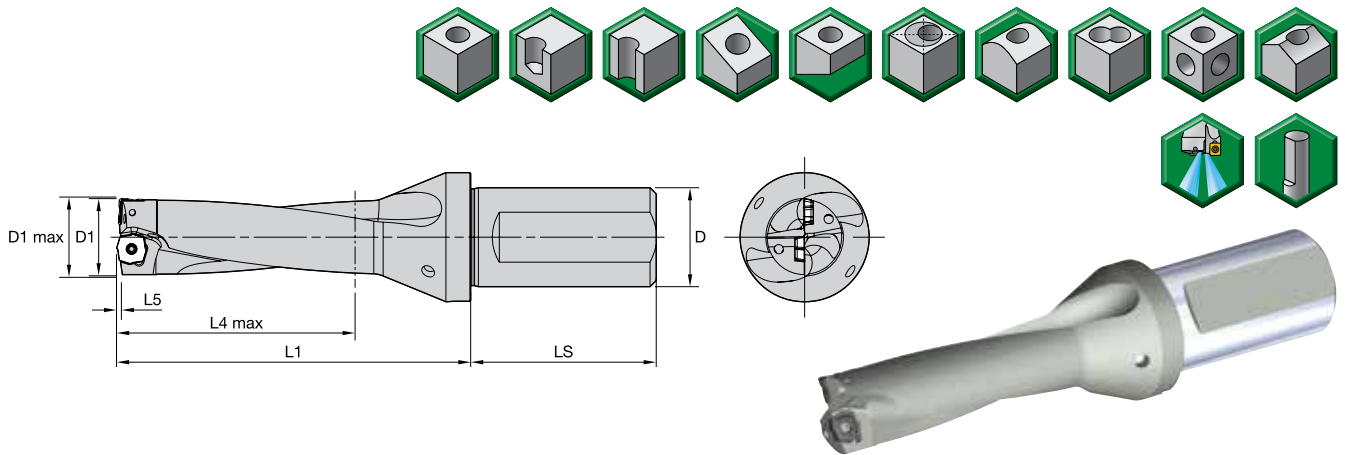

WARNING
During through-hole operations, a slug or disc is produced as the tool breaks through the workpiece. When the drill is stationary and the workpiece is rotating, this slug may be hurled from the chuck by centrifugal force. Provide adequate shielding to protect bystanders.

■ Top Cut 4 Drill • Metric • 3 x D • Side Lock Shank

order number	catalogue number	D1	D1 max	D	L1	L4 max	L5	insert size	gage insert outside	gage insert inside
5537863	TCF120R3SL20MA	12,00	13,00	20	66,6	36,0	0,41	A	TCF040204AP	TCF040203AC
5537864	TCF125R3SL20MA	12,50	13,50	20	68,3	37,5	0,48	A	TCF040204AP	TCF040203AC
5537866	TCF127R3SL20MA	12,70	13,70	20	68,9	38,1	0,51	A	TCF040204AP	TCF040203AC
5537867	TCF130R3SL20MA	13,00	14,00	20	69,9	39,0	0,56	A	TCF040204AP	TCF040203AC
5537868	TCF135R3SL20MA	13,50	14,50	20	71,6	41,0	0,64	A	TCF040204AP	TCF040203AC
5577928	TCF140R3SL25MB	14,00	15,00	25	73,8	42,0	0,42	B	TCF050204BP	TCF060203BC
5577929	TCF145R3SL25MB	14,50	15,50	25	75,4	43,5	0,45	B	TCF050204BP	TCF060203BC
5577930	TCF150R3SL25MB	15,00	16,00	25	77,1	45,0	0,49	B	TCF050204BP	TCF060203BC
5577931	TCF155R3SL25MB	15,50	16,50	25	78,8	46,5	0,54	B	TCF050204BP	TCF060203BC
5577932	TCF160R3SL25MB	16,00	17,00	25	80,4	48,0	0,60	B	TCF050204BP	TCF060203BC
5577933	TCF165R3SL25MB	16,50	17,50	25	82,1	49,5	0,68	B	TCF050204BP	TCF060203BC
5577934	TCF170R3SL25MB	17,00	18,00	25	85,4	51,0	0,74	B	TCF050204BP	TCF060203BC
5577935	TCF175R3SL25MB	17,50	18,50	25	87,1	52,5	0,79	B	TCF050204BP	TCF060203BC
5577936	TCF180R3SL25MB	18,00	19,00	25	88,8	54,0	0,86	B	TCF050204BP	TCF060203BC
5577937	TCF185R3SL25MB	18,50	19,50	25	90,4	55,5	0,83	B	TCF050204BP	TCF060203BC
5578828	TCF190R3SL25MC	19,00	20,00	25	91,1	57,0	0,60	C	TCF070306CP	TCF070304CC
5578829	TCF195R3SL25MC	19,50	20,50	25	92,7	58,5	0,70	C	TCF070306CP	TCF070304CC
5578830	TCF200R3SL25MC	20,00	21,00	25	94,4	60,0	0,70	C	TCF070306CP	TCF070304CC
5578831	TCF205R3SL25MC	20,50	21,50	25	96,1	61,5	0,70	C	TCF070306CP	TCF070304CC
5578832	TCF210R3SL25MC	21,00	22,00	25	97,7	63,0	0,80	C	TCF070306CP	TCF070304CC
5578833	TCF220R3SL25MC	22,00	23,00	25	101,0	66,0	1,00	C	TCF070306CP	TCF070304CC
5578834	TCF225R3SL25MC	22,50	23,50	25	102,7	67,5	1,10	C	TCF070306CP	TCF070304CC
5578835	TCF230R3SL25MC	23,00	24,00	25	104,4	69,0	1,10	C	TCF070306CP	TCF070304CC
5537824	TCF240R3SL25MD	24,00	25,00	25	111,2	72,0	0,78	D	TCF080308DP	TCF090305DC
5537825	TCF250R3SL32MD	25,00	26,00	32	114,6	75,0	0,86	D	TCF080308DP	TCF090305DC
5537826	TCF260R3SL32MD	26,00	27,00	32	117,9	78,0	0,97	D	TCF080308DP	TCF090305DC
5537827	TCF265R3SL32MD	26,50	27,50	32	119,5	79,5	1,05	D	TCF080308DP	TCF090305DC
5537828	TCF270R3SL32MD	27,00	28,00	32	121,2	81,0	1,15	D	TCF080308DP	TCF090305DC
5537829	TCF280R3SL32MD	28,00	29,00	32	124,5	84,0	1,30	D	TCF080308DP	TCF090305DC
5537830	TCF290R3SL32MD	29,00	30,00	32	127,8	87,0	1,45	D	TCF080308DP	TCF090305DC
5537944	TCF300R3SL32ME	30,00	31,00	32	130,2	90,0	0,63	E	TCF100408EP	TCF120405EC
5537945	TCF310R3SL32ME	31,00	32,00	32	133,5	93,0	0,72	E	TCF100408EP	TCF120405EC

(continued)

(Top Cut 4 Drill • Metric • 3 x D • Side Lock Shank – continued)

order number	catalogue number	D1	D1 max	D	L1	L4 max	L5	insert size	gage insert outside	gage insert inside
5537946	TCF320R3SL32ME	32,00	33,00	32	136,8	96,0	0,82	E	TCF100408EP	TCF120405EC
5537947	TCF330R3SL40ME	33,00	34,00	40	140,1	99,0	0,95	E	TCF100408EP	TCF120405EC
5537948	TCF340R3SL40ME	34,00	35,00	40	143,4	102,0	1,14	E	TCF100408EP	TCF120405EC
5537949	TCF350R3SL40ME	35,00	36,00	40	146,8	105,0	1,30	E	TCF100408EP	TCF120405EC
5537950	TCF360R3SL40ME	36,00	37,00	40	150,1	108,0	1,45	E	TCF100408EP	TCF120405EC
5578609	TCF370R3SL40MF	37,00	38,00	40	155,1	111,0	1,19	F	TCF120412FP	TCF150406FC
5578610	TCF375R3SL40MF	37,50	38,50	40	156,8	113,0	1,23	F	TCF120412FP	TCF150406FC
5578611	TCF380R3SL40MF	38,00	39,00	40	158,5	114,0	1,27	F	TCF120412FP	TCF150406FC
5578612	TCF390R3SL40MF	39,00	40,00	40	161,8	117,0	1,36	F	TCF120412FP	TCF150406FC
5578613	TCF400R3SL40MF	40,00	41,00	40	165,1	120,0	1,47	F	TCF120412FP	TCF150406FC
5578614	TCF410R3SL40MF	41,00	42,00	40	168,4	123,0	1,60	F	TCF120412FP	TCF150406FC
5578615	TCF420R3SL40MF	42,00	43,00	40	171,7	126,0	1,77	F	TCF120412FP	TCF150406FC
5578616	TCF430R3SL40MF	43,00	44,00	40	175,1	129,0	1,99	F	TCF120412FP	TCF150406FC
5578617	TCF440R3SL40MF	44,00	45,00	40	178,4	132,0	2,10	F	TCF120412FP	TCF150406FC
5578618	TCF450R3SL50MF	45,00	46,00	50	181,7	135,0	2,21	F	TCF120412FP	TCF150406FC
5578716	TCF460R3SL50MG	46,00	47,00	50	185,0	138,0	1,45	G	TCF150512GP	TCF180508GC
5578717	TCF470R3SL50MG	47,00	48,00	50	188,3	141,0	1,53	G	TCF150512GP	TCF180508GC
5578718	TCF480R3SL50MG	48,00	49,00	50	191,7	144,0	1,63	G	TCF150512GP	TCF180508GC
5578719	TCF490R3SL50MG	49,00	50,00	50	195,0	147,0	1,74	G	TCF150512GP	TCF180508GC
5578720	TCF500R3SL50MG	50,00	51,00	50	199,8	150,0	1,87	G	TCF150512GP	TCF180508GC
5578721	TCF505R3SL50MG	50,50	51,50	50	201,5	152,0	1,94	G	TCF150512GP	TCF180508GC
5578722	TCF510R3SL50MG	51,00	52,00	50	203,1	153,0	2,02	G	TCF150512GP	TCF180508GC
5578723	TCF520R3SL50MG	52,00	53,00	50	206,4	156,0	2,22	G	TCF150512GP	TCF180508GC
5578724	TCF530R3SL50MG	53,00	54,00	50	209,8	159,0	2,46	G	TCF150512GP	TCF180508GC
5578726	TCF540R3SL50MG	54,00	55,00	50	213,1	162,0	2,53	G	TCF150512GP	TCF180508GC
5578727	TCF550R3SL50MG	55,00	56,00	50	216,4	165,0	2,73	G	TCF150512GP	TCF180508GC
5578728	TCF560R3SL50MG	56,00	57,00	50	219,7	168,0	2,37	G	TCF150512GP	TCF180508GC
5538635	TCF570R3SL50MH	57,00	58,00	50	222,5	171,0	1,76	H	TCF180614HP	TCF210608HC
5538636	TCF580R3SL50MH	58,00	59,00	50	225,9	174,0	1,85	H	TCF180614HP	TCF210608HC
5538637	TCF590R3SL50MH	59,00	60,00	50	229,2	177,0	1,96	H	TCF180614HP	TCF210608HC
5538638	TCF600R3SL50MH	60,00	61,00	50	232,5	180,0	1,42	H	TCF180614HP	TCF210608HC
5538639	TCF610R3SL50MH	61,00	62,00	50	235,8	183,0	2,23	H	TCF180614HP	TCF210608HC
5538640	TCF620R3SL50MH	62,00	63,00	50	239,1	186,0	2,41	H	TCF180614HP	TCF210608HC
5538641	TCF630R3SL50MH	63,00	64,00	50	242,5	189,0	2,64	H	TCF180614HP	TCF210608HC
5538642	TCF640R3SL50MH	64,00	65,00	50	245,8	192,0	2,94	H	TCF180614HP	TCF210608HC
5538643	TCF650R3SL50MH	65,00	66,00	50	249,1	195,0	3,06	H	TCF180614HP	TCF210608HC
5538644	TCF660R3SL50MH	66,00	67,00	50	252,4	198,0	3,18	H	TCF180614HP	TCF210608HC
5538645	TCF670R3SL50MH	67,00	68,00	50	255,7	201,0	3,30	H	TCF180614HP	TCF210608HC
5538646	TCF680R3SL50MH	68,00	69,00	50	259,1	204,0	2,93	H	TCF180614HP	TCF210608HC

(continued)

(Top Cut 4 Drill • Metric • 3 x D • Side Lock Shank – continued)

■ Spare Parts



insert size	periphery	centre	insert screw	Torx size	Torx driver	tightening torque Nm
A	TCF040204AP	TCF040203AC	12146011800	T5	12146010000	0,40
B	TCF050204BP	TCF060203BC	193.281	T6	170027	0,53
C	TCF070306CP	TCF070304CC	MS1152	T7	12147549000	0,90
D	TCF080308DP	TCF090305DC	192.432	T8	12148086600	1,10
E	TCF100408EP	TCF120405EC	12748610000	T9	170024	2,00
F	TCF120412FP	TCF150406FC	193.332	T15	12148082400	4,00
G	TCF150512GP	TCF180508GC	MS1160	T20	12148007500	6,30
H	TCF180614HP	TCF210608HC	MS1982	T25	1022519	8,80

D	LS
25,00	56
32,00	60
40,00	70
50,00	80

NOTE: Drilling in stacked plates possible in certain applications. Ask for technical support.

WARNING

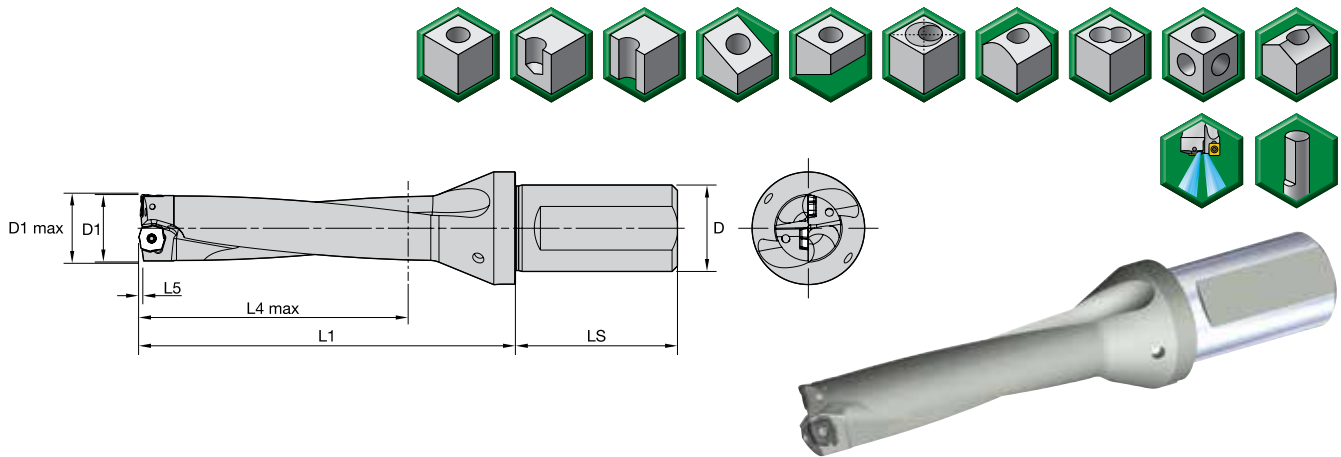
During through-hole operations, a slug or disc is produced as the tool breaks through the workpiece. When the drill is stationary and the workpiece is rotating, this slug may be hurled from the chuck by centrifugal force. Provide adequate shielding to protect bystanders.



■ Top Cut 4 Drill • Metric • 4 x D • Side Lock Shank

order number	catalogue number	D1	D1 max	D	L1	L4 max	L5	insert size	gage insert outside	gage insert inside
5537869	TCF120R4SL20MA	12,00	13,00	20	78,6	48,0	0,41	A	TCF040204AP	TCF040203AC
5537870	TCF125R4SL20MA	12,50	13,50	20	80,8	50,0	0,48	A	TCF040204AP	TCF040203AC
5537871	TCF127R4SL20MA	12,70	13,70	20	81,6	50,8	0,51	A	TCF040204AP	TCF040203AC
5537872	TCF130R4SL20MA	13,00	14,00	20	82,9	52,0	0,56	A	TCF040204AP	TCF040203AC
5537873	TCF135R4SL20MA	13,50	14,50	20	85,1	54,0	0,64	A	TCF040204AP	TCF040203AC
5577938	TCF140R4SL25MB	14,00	15,00	25	87,8	56,0	0,42	B	TCF050204BP	TCF060203BC
5577939	TCF145R4SL25MB	14,50	15,50	25	89,9	58,0	0,45	B	TCF050204BP	TCF060203BC
5577940	TCF150R4SL25MB	15,00	16,00	25	92,1	60,0	0,49	B	TCF050204BP	TCF060203BC
5577941	TCF155R4SL25MB	15,50	16,50	25	94,3	62,0	0,54	B	TCF050204BP	TCF060203BC
5577942	TCF160R4SL25MB	16,00	17,00	25	96,4	64,0	0,60	B	TCF050204BP	TCF060203BC
5577943	TCF165R4SL25MB	16,50	17,50	25	98,6	66,0	0,68	B	TCF050204BP	TCF060203BC
5577944	TCF170R4SL25MB	17,00	18,00	25	102,4	68,0	0,74	B	TCF050204BP	TCF060203BC
5577945	TCF175R4SL25MB	17,50	18,50	25	104,6	70,0	0,79	B	TCF050204BP	TCF060203BC
5577946	TCF180R4SL25MB	18,00	19,00	25	106,8	72,0	0,86	B	TCF050204BP	TCF060203BC
5577947	TCF185R4SL25MB	18,50	19,50	25	108,9	74,0	0,83	B	TCF050204BP	TCF060203BC
5578836	TCF190R4SL25MC	19,00	20,00	25	110,1	76,0	0,60	C	TCF070306CP	TCF070304CC
5578837	TCF195R4SL25MC	19,50	20,50	25	112,2	78,0	0,70	C	TCF070306CP	TCF070304CC
5578838	TCF200R4SL25MC	20,00	21,00	25	114,4	80,0	0,70	C	TCF070306CP	TCF070304CC
5578839	TCF205R4SL25MC	20,50	21,50	25	116,6	82,0	0,70	C	TCF070306CP	TCF070304CC
5578840	TCF210R4SL25MC	21,00	22,00	25	118,7	84,0	0,80	C	TCF070306CP	TCF070304CC
5578841	TCF220R4SL25MC	22,00	23,00	25	123,0	88,0	1,00	C	TCF070306CP	TCF070304CC
5578842	TCF225R4SL25MC	22,50	23,50	25	125,2	90,0	1,10	C	TCF070306CP	TCF070304CC
5578843	TCF230R4SL25MC	23,00	24,00	25	127,4	92,0	1,10	C	TCF070306CP	TCF070304CC
5537831	TCF240R4SL25MD	24,00	25,00	25	135,2	96,0	0,78	D	TCF080308DP	TCF090305DC
5537832	TCF250R4SL32MD	25,00	26,00	32	139,6	100,0	0,86	D	TCF080308DP	TCF090305DC
5537833	TCF260R4SL32MD	26,00	27,00	32	143,9	104,0	0,97	D	TCF080308DP	TCF090305DC
5537834	TCF265R4SL32MD	26,50	27,50	32	146,0	106,0	1,05	D	TCF080308DP	TCF090305DC
5537835	TCF270R4SL32MD	27,00	28,00	32	148,2	108,0	1,15	D	TCF080308DP	TCF090305DC
5537836	TCF280R4SL32MD	28,00	29,00	32	152,5	112,0	1,30	D	TCF080308DP	TCF090305DC
5537837	TCF290R4SL32MD	29,00	30,00	32	156,8	116,0	1,45	D	TCF080308DP	TCF090305DC
5537951	TCF300R4SL32ME	30,00	31,00	32	160,2	120,0	0,63	E	TCF100408EP	TCF120405EC
5537952	TCF310R4SL32ME	31,00	32,00	32	164,5	124,0	0,72	E	TCF100408EP	TCF120405EC

(continued)

(Top Cut 4 Drill • Metric • 4 x D • Side Lock Shank – continued)

order number	catalogue number	D1	D1 max	D	L1	L4 max	L5	insert size	gage insert outside	gage insert inside
5537953	TCF320R4SL32ME	32,00	33,00	32	168,8	128,0	0,82	E	TCF100408EP	TCF120405EC
5537954	TCF330R4SL40ME	33,00	34,00	40	173,1	132,0	0,95	E	TCF100408EP	TCF120405EC
5537955	TCF340R4SL40ME	34,00	35,00	40	177,4	136,0	1,14	E	TCF100408EP	TCF120405EC
5537956	TCF350R4SL40ME	35,00	36,00	40	181,8	140,0	1,30	E	TCF100408EP	TCF120405EC
5537957	TCF360R4SL40ME	36,00	37,00	40	186,1	144,0	1,45	E	TCF100408EP	TCF120405EC
5578619	TCF370R4SL40MF	37,00	38,00	40	192,1	148,0	1,19	F	TCF120412FP	TCF150406FC
5578620	TCF375R4SL40MF	37,50	38,50	40	194,3	150,0	1,23	F	TCF120412FP	TCF150406FC
5578621	TCF380R4SL40MF	38,00	39,00	40	196,5	152,0	1,27	F	TCF120412FP	TCF150406FC
5578622	TCF390R4SL40MF	39,00	40,00	40	200,8	156,0	1,36	F	TCF120412FP	TCF150406FC
5578623	TCF400R4SL40MF	40,00	41,00	40	205,1	160,0	1,47	F	TCF120412FP	TCF150406FC
5578624	TCF410R4SL40MF	41,00	42,00	40	209,4	164,0	1,60	F	TCF120412FP	TCF150406FC
5578625	TCF420R4SL40MF	42,00	43,00	40	213,7	168,0	1,77	F	TCF120412FP	TCF150406FC
5578626	TCF430R4SL40MF	43,00	44,00	40	218,1	172,0	1,99	F	TCF120412FP	TCF150406FC
5578627	TCF440R4SL40MF	44,00	45,00	40	222,4	176,0	2,10	F	TCF120412FP	TCF150406FC
5578628	TCF450R4SL50MF	45,00	46,00	50	226,7	180,0	2,21	F	TCF120412FP	TCF150406FC
5578729	TCF460R4SL50MG	46,00	47,00	50	231,0	184,0	1,45	G	TCF150512GP	TCF180508GC
5578730	TCF470R4SL50MG	47,00	48,00	50	235,3	188,0	1,53	G	TCF150512GP	TCF180508GC
5578731	TCF480R4SL50MG	48,00	49,00	50	239,7	192,0	1,63	G	TCF150512GP	TCF180508GC
5578732	TCF490R4SL50MG	49,00	50,00	50	244,0	196,0	1,74	G	TCF150512GP	TCF180508GC
5578733	TCF500R4SL50MG	50,00	51,00	50	249,8	200,0	1,87	G	TCF150512GP	TCF180508GC
5578734	TCF505R4SL50MG	50,50	51,50	50	252,0	202,0	1,94	G	TCF150512GP	TCF180508GC
5578735	TCF510R4SL50MG	51,00	52,00	50	254,1	204,0	2,02	G	TCF150512GP	TCF180508GC
5578736	TCF520R4SL50MG	52,00	53,00	50	258,4	208,0	2,22	G	TCF150512GP	TCF180508GC
5578737	TCF530R4SL50MG	53,00	54,00	50	262,8	212,0	2,46	G	TCF150512GP	TCF180508GC
5578738	TCF540R4SL50MG	54,00	55,00	50	267,1	216,0	2,53	G	TCF150512GP	TCF180508GC
5578739	TCF550R4SL50MG	55,00	56,00	50	271,4	220,0	2,73	G	TCF150512GP	TCF180508GC
5578750	TCF560R4SL50MG	56,00	57,00	50	275,7	224,0	2,37	G	TCF150512GP	TCF180508GC
5538647	TCF570R4SL50MH	57,00	58,00	50	279,5	228,0	1,76	H	TCF180614HP	TCF210608HC
5538648	TCF580R4SL50MH	58,00	59,00	50	283,9	232,0	1,85	H	TCF180614HP	TCF210608HC
5538649	TCF590R4SL50MH	59,00	60,00	50	288,2	236,0	1,96	H	TCF180614HP	TCF210608HC
5538650	TCF600R4SL50MH	60,00	61,00	50	292,5	240,0	1,42	H	TCF180614HP	TCF210608HC
5538651	TCF610R4SL50MH	61,00	62,00	50	296,8	244,0	2,23	H	TCF180614HP	TCF210608HC
5538652	TCF620R4SL50MH	62,00	63,00	50	301,1	248,0	2,41	H	TCF180614HP	TCF210608HC
5538653	TCF630R4SL50MH	63,00	64,00	50	305,5	252,0	2,64	H	TCF180614HP	TCF210608HC
5538654	TCF640R4SL50MH	64,00	65,00	50	309,8	256,0	2,94	H	TCF180614HP	TCF210608HC
5538655	TCF650R4SL50MH	65,00	66,00	50	314,1	260,0	3,06	H	TCF180614HP	TCF210608HC
5538656	TCF660R4SL50MH	66,00	67,00	50	318,4	264,0	3,18	H	TCF180614HP	TCF210608HC
5538657	TCF670R4SL50MH	67,00	68,00	50	322,7	268,0	3,30	H	TCF180614HP	TCF210608HC
5538658	TCF680R4SL50MH	68,00	69,00	50	327,1	272,0	2,93	H	TCF180614HP	TCF210608HC

(continued)

(Top Cut 4 Drill • Metric • 4 x D • Side Lock Shank – continued)

■ Spare Parts



insert size	periphery	centre	insert screw	Torx size	Torx driver	tightening torque Nm
A	TCF040204AP	TCF040203AC	12146011800	T5	12146010000	0,40
B	TCF050204BP	TCF060203BC	193.281	T6	170027	0,53
C	TCF070306CP	TCF070304CC	MS1152	T7	12147549000	0,90
D	TCF080308DP	TCF090305DC	192.432	T8	12148086600	1,10
E	TCF100408EP	TCF120405EC	12748610000	T9	170024	2,00
F	TCF120412FP	TCF150406FC	193.332	T15	12148082400	4,00
G	TCF150512GP	TCF180508GC	MS1160	T20	12148007500	6,30
H	TCF180614HP	TCF210608HC	MS1982	T25	1022519	8,80

D	LS
25,00	56
32,00	60
40,00	70
50,00	80

NOTE: Drilling in stacked plates possible in certain applications. Ask for technical support.



WARNING

During through-hole operations, a slug or disc is produced as the tool breaks through the workpiece. When the drill is stationary and the workpiece is rotating, this slug may be hurled from the chuck by centrifugal force. Provide adequate shielding to protect bystanders.

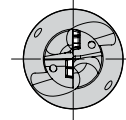
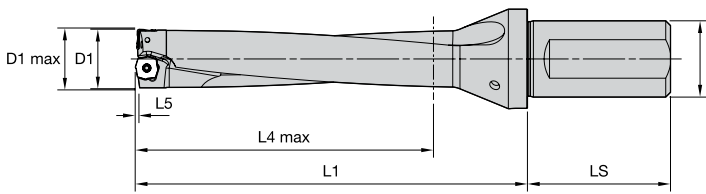
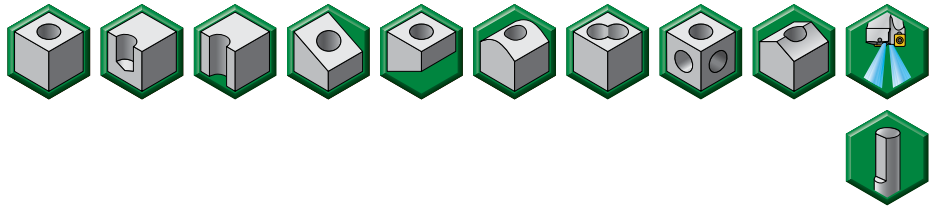
■ Top Cut 4 Drill • Metric • 5 x D • Side Lock Shank

order number	catalogue number	D1	D	L1	L4 max	L5	insert size	gage insert outside	gage insert inside
5537874	TCF120R5SL20MA	12,00	20	86,0	60,0	0,41	A	TCF040204AP	TCF040203AC
5537875	TCF125R5SL20MA	12,50	20	93,3	63,0	0,48	A	TCF040204AP	TCF040203AC
5537876	TCF127R5SL20MA	12,70	20	94,3	63,5	0,51	A	TCF040204AP	TCF040203AC
5537877	TCF130R5SL20MA	13,00	20	95,9	65,0	0,56	A	TCF040204AP	TCF040203AC
5537878	TCF135R5SL20MA	13,50	20	98,6	68,0	0,64	A	TCF040204AP	TCF040203AC
5577948	TCF140R5SL25MB	14,00	25	101,8	70,0	0,42	B	TCF050204BP	TCF060203BC
5577949	TCF145R5SL25MB	14,50	25	104,4	72,5	0,45	B	TCF050204BP	TCF060203BC
5577950	TCF150R5SL25MB	15,00	25	107,1	75,0	0,49	B	TCF050204BP	TCF060203BC
5577951	TCF155R5SL25MB	15,50	25	109,8	77,5	0,54	B	TCF050204BP	TCF060203BC
5577952	TCF160R5SL25MB	16,00	25	112,4	80,0	0,60	B	TCF050204BP	TCF060203BC
5577953	TCF165R5SL25MB	16,50	25	115,1	82,5	0,68	B	TCF050204BP	TCF060203BC
5577954	TCF170R5SL25MB	17,00	25	119,4	85,0	0,74	B	TCF050204BP	TCF060203BC
5577955	TCF175R5SL25MB	17,50	25	122,1	87,5	0,79	B	TCF050204BP	TCF060203BC
5577956	TCF180R5SL25MB	18,00	25	124,8	90,0	0,86	B	TCF050204BP	TCF060203BC
5577957	TCF185R5SL25MB	18,50	25	127,4	92,5	0,83	B	TCF050204BP	TCF060203BC
5578844	TCF190R5SL25MC	19,00	25	129,1	95,0	0,60	C	TCF070306CP	TCF070304CC
5578845	TCF195R5SL25MC	19,50	25	131,7	97,5	0,70	C	TCF070306CP	TCF070304CC
5578846	TCF200R5SL25MC	20,00	25	134,4	100,0	0,70	C	TCF070306CP	TCF070304CC
5578847	TCF205R5SL25MC	20,50	25	137,1	102,5	0,70	C	TCF070306CP	TCF070304CC
5578848	TCF210R5SL25MC	21,00	25	139,7	105,0	0,80	C	TCF070306CP	TCF070304CC
5578849	TCF220R5SL25MC	22,00	25	145,0	110,0	1,00	C	TCF070306CP	TCF070304CC
5578850	TCF225R5SL25MC	22,50	25	147,7	112,5	1,10	C	TCF070306CP	TCF070304CC
5578851	TCF230R5SL25MC	23,00	25	150,4	115,0	1,10	C	TCF070306CP	TCF070304CC
5537838	TCF240R5SL25MD	24,00	25	159,2	120,0	0,78	D	TCF080308DP	TCF090305DC
5537839	TCF250R5SL32MD	25,00	32	164,6	125,0	0,86	D	TCF080308DP	TCF090305DC
5537840	TCF260R5SL32MD	26,00	32	169,9	130,0	0,97	D	TCF080308DP	TCF090305DC
5537841	TCF265R5SL32MD	26,50	32	172,5	132,5	1,05	D	TCF080308DP	TCF090305DC
5537842	TCF270R5SL32MD	27,00	32	175,2	135,0	1,15	D	TCF080308DP	TCF090305DC
5537843	TCF280R5SL32MD	28,00	32	180,5	140,0	1,30	D	TCF080308DP	TCF090305DC
5537844	TCF290R5SL32MD	29,00	32	185,8	145,0	1,45	D	TCF080308DP	TCF090305DC
5537958	TCF300R5SL32ME	30,00	32	190,2	150,0	0,63	E	TCF100408EP	TCF120405EC
5537959	TCF310R5SL32ME	31,00	32	195,5	155,0	0,72	E	TCF100408EP	TCF120405EC

(continued)

(Top Cut 4 Drill • Metric • 5 x D • Side Lock Shank – continued)

order number	catalogue number	D1	D	L1	L4 max	L5	insert size	gage insert outside	gage insert inside
5537960	TCF320R5SL32ME	32,00	32	200,8	160,0	0,82	E	TCF100408EP	TCF120405EC
5537961	TCF330R5SL40ME	33,00	40	206,1	165,0	0,95	E	TCF100408EP	TCF120405EC
5537962	TCF340R5SL40ME	34,00	40	211,4	170,0	1,14	E	TCF100408EP	TCF120405EC
5537963	TCF350R5SL40ME	35,00	40	216,8	175,0	1,30	E	TCF100408EP	TCF120405EC
5537964	TCF360R5SL40ME	36,00	40	222,1	180,0	1,45	E	TCF100408EP	TCF120405EC
5578629	TCF370R5SL40MF	37,00	40	229,1	185,0	1,19	F	TCF120412FP	TCF150406FC
5578640	TCF375R5SL40MF	37,50	40	231,8	188,0	1,23	F	TCF120412FP	TCF150406FC
5578641	TCF380R5SL40MF	38,00	40	234,5	190,0	1,27	F	TCF120412FP	TCF150406FC
5578642	TCF390R5SL40MF	39,00	40	239,8	195,0	1,36	F	TCF120412FP	TCF150406FC
5578643	TCF400R5SL40MF	40,00	40	245,1	200,0	1,47	F	TCF120412FP	TCF150406FC
5578644	TCF410R5SL40MF	41,00	40	250,4	205,0	1,60	F	TCF120412FP	TCF150406FC
5578645	TCF420R5SL40MF	42,00	40	255,7	210,0	1,77	F	TCF120412FP	TCF150406FC
5578646	TCF430R5SL40MF	43,00	40	261,1	215,0	1,99	F	TCF120412FP	TCF150406FC
5578647	TCF440R5SL40MF	44,00	40	266,4	220,0	2,10	F	TCF120412FP	TCF150406FC
5578648	TCF450R5SL50MF	45,00	50	271,7	225,0	2,21	F	TCF120412FP	TCF150406FC
5578751	TCF460R5SL50MG	46,00	50	277,0	230,0	1,45	G	TCF150512GP	TCF180508GC
5578752	TCF470R5SL50MG	47,00	50	282,3	235,0	1,53	G	TCF150512GP	TCF180508GC
5578753	TCF480R5SL50MG	48,00	50	287,7	240,0	1,63	G	TCF150512GP	TCF180508GC
5578754	TCF490R5SL50MG	49,00	50	293,0	245,0	1,74	G	TCF150512GP	TCF180508GC
5578755	TCF500R5SL50MG	50,00	50	299,8	250,0	1,87	G	TCF150512GP	TCF180508GC
5578756	TCF505R5SL50MG	50,50	50	302,5	253,0	1,94	G	TCF150512GP	TCF180508GC
5578757	TCF510R5SL50MG	51,00	50	305,1	255,0	2,02	G	TCF150512GP	TCF180508GC
5578758	TCF520R5SL50MG	52,00	50	310,4	260,0	2,22	G	TCF150512GP	TCF180508GC
5578759	TCF530R5SL50MG	53,00	50	315,8	265,0	2,46	G	TCF150512GP	TCF180508GC
5578760	TCF540R5SL50MG	54,00	50	321,1	270,0	2,53	G	TCF150512GP	TCF180508GC
5578761	TCF550R5SL50MG	55,00	50	326,4	275,0	2,73	G	TCF150512GP	TCF180508GC
5578762	TCF560R5SL50MG	56,00	50	331,7	280,0	2,37	G	TCF150512GP	TCF180508GC
5538659	TCF570R5SL50MH	57,00	50	336,5	285,0	1,76	H	TCF180614HP	TCF210608HC
5538680	TCF580R5SL50MH	58,00	50	341,9	290,0	1,85	H	TCF180614HP	TCF210608HC
5538681	TCF590R5SL50MH	59,00	50	347,2	295,0	1,96	H	TCF180614HP	TCF210608HC
5538682	TCF600R5SL50MH	60,00	50	352,5	300,0	1,42	H	TCF180614HP	TCF210608HC
5538683	TCF610R5SL50MH	61,00	50	357,8	305,0	2,23	H	TCF180614HP	TCF210608HC
5538684	TCF620R5SL50MH	62,00	50	363,1	310,0	2,41	H	TCF180614HP	TCF210608HC
5538685	TCF630R5SL50MH	63,00	50	368,5	315,0	2,64	H	TCF180614HP	TCF210608HC
5538686	TCF640R5SL50MH	64,00	50	373,8	320,0	2,94	H	TCF180614HP	TCF210608HC
5538687	TCF650R5SL50MH	65,00	50	379,1	325,0	3,06	H	TCF180614HP	TCF210608HC
5538688	TCF660R5SL50MH	66,00	50	384,4	330,0	3,18	H	TCF180614HP	TCF210608HC
5538689	TCF670R5SL50MH	67,00	50	389,7	335,0	3,30	H	TCF180614HP	TCF210608HC
5538700	TCF680R5SL50MH	68,00	50	395,1	340,0	2,93	H	TCF180614HP	TCF210608HC

(continued)

(Top Cut 4 Drill • Metric • 5 x D • Side Lock Shank – continued)

■ Spare Parts

insert size	periphery	centre	insert screw	Torx size	Torx driver	tightening torque Nm
A	TCF040204AP	TCF040203AC	12146011800	T5	12146010000	0,40
B	TCF050204BP	TCF060203BC	193.281	T6	170027	0,53
C	TCF070306CP	TCF070304CC	MS1152	T7	12147549000	0,90
D	TCF080308DP	TCF090305DC	192.432	T8	12148086600	1,10
E	TCF100408EP	TCF120405EC	12748610000	T9	170024	2,00
F	TCF120412FP	TCF150406FC	193.332	T15	12148082400	4,00
G	TCF150512GP	TCF180508GC	MS1160	T20	12148007500	6,30
H	TCF180614HP	TCF210608HC	MS1982	T25	1022519	8,80

D	LS
25,00	56
32,00	60
40,00	70
50,00	80

WARNING

During through-hole operations, a slug or disc is produced as the tool breaks through the workpiece. When the drill is stationary and the workpiece is rotating, this slug may be hurled from the chuck by centrifugal force. Provide adequate shielding to protect bystanders.

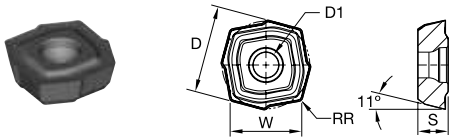

● first choice
○ alternate choice

P	●	●	●
M	●	●	●
K	●	●	●
N	○	○	○
S	○	○	○
H	○	○	○

■ Top Cut 4 Drill • Centre Inserts • V34

catalogue number	D	D1	W	S	RR	insert size	WPK10CH	WU25CH	WU40PH
TCF040203ACV34	4,47	2,10	3,65	2,00	0,300	A	5541817	5541818	
TCF060203BCV34	6,00	2,40	4,90	2,40	0,300	B	5542602	5542604	
TCF070304CCV34	7,59	2,60	6,20	2,80	0,400	C	5542642	5542643	
TCF090305DCV34	9,55	2,80	7,80	3,00	0,500	D	5538554	5538555	
TCF120405ECV34	12,00	3,40	9,80	3,60	0,500	E	5538603	5538604	
TCF150406FCV34	14,94	4,80	12,20	4,20	0,600	F	5542623	5542624	
TCF180508GCV34	17,88	6,00	14,60	5,40	0,800	G	5542475	5542476	
TCF210608HCV34	21,68	7,50	17,70	6,50	0,800	H	5542002	5542003	

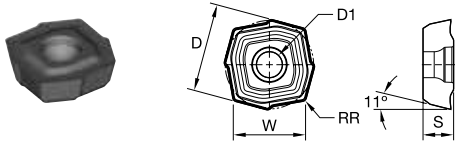

● first choice
○ alternate choice

P	<input checked="" type="checkbox"/>	<input checked="" type="checkbox"/>	<input checked="" type="checkbox"/>
M	<input checked="" type="checkbox"/>	<input checked="" type="checkbox"/>	<input checked="" type="checkbox"/>
K	<input checked="" type="checkbox"/>	<input checked="" type="checkbox"/>	<input checked="" type="checkbox"/>
N	<input type="checkbox"/>	<input type="checkbox"/>	<input type="checkbox"/>
S	<input type="checkbox"/>	<input type="checkbox"/>	<input type="checkbox"/>
H	<input type="checkbox"/>	<input type="checkbox"/>	<input type="checkbox"/>

■ Top Cut 4 Drill • Centre Inserts • V36

catalogue number	D	D1	W	S	RR	insert size	WPK10CH	WU25CH	WU40PH
TCF040203ACV36	4,47	2,10	3,65	2,00	0,300	A		5541819	5541840
TCF060203BCV36	6,00	2,40	4,90	2,40	0,300	B		5542606	5542607
TCF070304CCV36	7,59	2,60	6,20	2,80	0,400	C		5542644	5542645
TCF090305DCV36	9,55	2,80	7,80	3,00	0,500	D		5538556	5538557
TCF120405ECV36	12,00	3,40	9,80	3,60	0,500	E		5538606	5538607
TCF150406FCV36	14,94	4,80	12,20	4,20	0,600	F		5542625	5542626
TCF180508GCV36	17,88	6,00	14,60	5,40	0,800	G		5542477	5542478
TCF210608HCV36	21,68	7,50	17,70	6,50	0,800	H		5542004	5542005

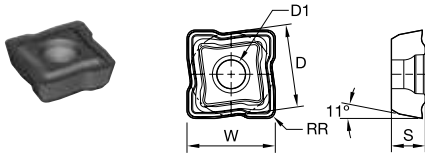

● first choice
○ alternate choice

P	●	●	●
M	●	●	●
K	●	●	●
N	○	○	○
S	○	○	○
H	○	○	○

■ Top Cut 4 Drill • Periphery Inserts • V34

catalogue number	D	D1	W	S	RR	insert size	WPK10CH	WU25CH	WU40PH
TCF040204APV34	4,14	2,10	4,40	2,00	0,400	A	5541843	5541841	5541842
TCF050204BPV34	5,07	2,40	5,40	2,40	0,400	B	5542620	5542608	5542609
TCF070306CPV34	6,67	2,60	7,10	2,80	0,600	C	5542648	5542646	5542647
TCF080308DPV34	8,08	2,80	8,60	3,00	0,800	D	5538600	5538558	5538559
TCF100408EPV34	9,96	3,40	10,60	3,60	0,800	E	5538610	5538608	5538609
TCF120412FPV34	12,59	4,80	13,40	4,20	1,200	F	5542629	5542627	5542628
TCF150512GPV34	15,13	6,00	16,10	5,40	1,200	G	5542601	5542479	5542600
TCF180614HPV34	18,04	7,50	19,20	6,50	1,400	H	5542008	5542006	5542007

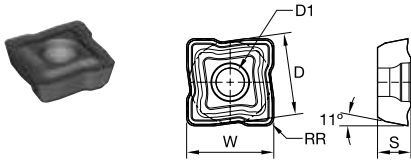

● first choice
 ○ alternate choice

P	●	●	●
M	●	●	●
K	●	●	●
N	○	○	○
S	○	○	○
H	○	○	○

■ Top Cut 4 Drill • Periphery Inserts • V36

catalogue number	D	D1	W	S	RR	insert size	WPK10CH	WU25CH	WU40PH
TCF040204APV36	4,14	2,10	4,40	2,00	0,400	A	5541844	5541845	
TCF050204BPV36	5,07	2,40	5,40	2,40	0,400	B	5542621	5542622	
TCF070306CPV36	6,67	2,60	7,10	2,80	0,600	C	5542649	5542650	
TCF080308DPV36	8,08	2,80	8,60	3,00	0,800	D	5538601	5538602	
TCF100408EPV36	9,96	3,40	10,60	3,60	0,800	E	5538611	5538612	
TCF120412FPV36	12,59	4,80	13,40	4,20	1,200	F	5542640	5542641	
TCF150512GPV36	15,13	6,00	16,10	5,40	1,200	G	5542603	5542605	
TCF180614HPV36	18,04	7,50	19,20	6,50	1,400	H	5542009	5542020	

■ Top Cut 4 • Steel • 2 x D/3 x D • Feed Chart • Metric

Top Cut 4					Recommended Feed Rate by Diameter (mm/r)												
					Insert Size A			Insert Size B			Insert Size C			Insert Size D			
					TCF040203AC TCF040204AP 12,00–13,99mm			TCF060203BC TCF050204BP 14,00–18,99mm			TCF070304CC TCF070306CP 19,00–23,99mm			TCF090305DC TCF080308DP 24,00–29,99mm			
Material Group	Condition	Pocket Seat	Geometry	Grade	min	Start	max	min	Start	max	min	Start	max	min	Start	max	
P	1	S	P	V36	WU25CH	0,06	0,08	0,10	0,08	0,10	0,13	0,10	0,12	0,15	0,11	0,13	0,16
			C	V36	WU40PH												
		U	P	V36	WU40PH	0,06	0,08	0,10	0,08	0,10	0,13	0,10	0,12	0,15	0,11	0,13	0,16
			C	V36	WU40PH												
		I	P	V36	WU40PH	0,06	0,08	0,10	0,08	0,10	0,13	0,10	0,12	0,15	0,11	0,13	0,16
			C	V36	WU40PH												
	2	S	P	V34	WPK10CH	0,06	0,08	0,10	0,08	0,12	0,15	0,10	0,13	0,16	0,11	0,14	0,17
			C	V34	WU40PH												
		U	P	V34	WU25CH	0,06	0,08	0,10	0,08	0,12	0,15	0,10	0,13	0,16	0,11	0,14	0,17
			C	V34	WU40PH												
		I	P	V34	WU40PH	0,06	0,08	0,10	0,08	0,12	0,15	0,10	0,13	0,16	0,11	0,14	0,17
			C	V34	WU40PH												
	3	S	P	V34	WPK10CH	0,08	0,11	0,15	0,10	0,12	0,16	0,11	0,14	0,18	0,12	0,15	0,20
			C	V34	WU40PH												
		U	P	V34	WU25CH	0,08	0,11	0,14	0,10	0,12	0,15	0,11	0,14	0,16	0,12	0,15	0,18
			C	V34	WU40PH												
		I	P	V34	WU40PH	0,08	0,11	0,14	0,10	0,12	0,15	0,11	0,14	0,16	0,12	0,15	0,18
			C	V34	WU40PH												
	4	S	P	V34	WPK10CH	0,08	0,11	0,15	0,10	0,12	0,16	0,11	0,14	0,18	0,12	0,15	0,20
			C	V34	WU40PH												
		U	P	V34	WU25CH	0,08	0,11	0,14	0,10	0,12	0,15	0,11	0,14	0,16	0,12	0,15	0,18
			C	V34	WU40PH												
		I	P	V34	WU40PH	0,08	0,11	0,14	0,10	0,12	0,15	0,11	0,14	0,16	0,12	0,15	0,18
			C	V34	WU40PH												
5	S	P	V36	WU25CH	0,06	0,08	0,10	0,08	0,10	0,14	0,10	0,12	0,15	0,11	0,13	0,16	
		C	V36	WU40PH													
	U	P	V36	WU40PH	0,06	0,08	0,10	0,08	0,10	0,14	0,10	0,12	0,15	0,11	0,13	0,16	
		C	V36	WU40PH													
	I	P	V36	WU40PH	0,06	0,08	0,10	0,08	0,10	0,14	0,10	0,12	0,15	0,11	0,13	0,16	
		C	V36	WU40PH													
6	S	P	V36	WU25CH	0,06	0,08	0,10	0,08	0,10	0,14	0,10	0,12	0,15	0,11	0,13	0,16	
		C	V36	WU40PH													
	U	P	V36	WU40PH	0,06	0,08	0,10	0,08	0,10	0,14	0,10	0,12	0,15	0,11	0,13	0,16	
		C	V36	WU40PH													
	I	P	V36	WU40PH	0,06	0,08	0,10	0,08	0,10	0,14	0,10	0,12	0,15	0,11	0,13	0,16	
		C	V36	WU40PH													

NOTE: For 4 x D, it is highly recommended to start with feed and speed values reduced by 10% less than above recommendations.
 For 5 x D, diameter range 12–23,99mm (insert sizes A to C), it is highly recommended to start with feed and speed values reduced by 20% less than above recommendations.
 For 5 x D, diameter range 24–68mm (insert sizes D to H), it is highly recommended to start with feed and speed values reduced by 15% less than above recommendations.
 For 4 x D and 5 x D, it is recommended to reduce the feed rate during entry and exit by 30–50%.

■ Top Cut 4 • Steel • 2 x D/3 x D • Feed Chart • Metric

Top Cut 4					Recommended Feed Rate by Diameter (mm/r)												
					Insert Size E			Insert Size F			Insert Size G			Insert Size H			
					TCF120405EC TCF100408EP 30,00–36,99mm			TCF150406FC TCF120412FP 37,00–45,99mm			TCF180508GC TCF150512GP 46,00–56,99mm			TCF210608HC TCF180614HP 57,00–68,00mm			
Material Group	Condition	Pocket Seat	Geometry	Grade	min	Start	max	min	Start	max	min	Start	max	min	Start	max	
P	1	S	P	V36	WU25CH	0,13	0,14	0,18	0,15	0,17	0,20	0,16	0,23	0,27	0,17	0,24	0,29
			C	V36	WU40PH												
		U	P	V36	WU40PH	0,06	0,08	0,10	0,08	0,10	0,13	0,10	0,12	0,15	0,11	0,13	0,16
			C	V36	WU40PH												
		I	P	V36	WU40PH	0,06	0,08	0,10	0,08	0,10	0,13	0,10	0,12	0,15	0,11	0,13	0,16
			C	V36	WU40PH												
	2	S	P	V34	WPK10CH	0,06	0,08	0,10	0,08	0,12	0,15	0,10	0,13	0,16	0,11	0,14	0,17
			C	V34	WU40PH												
		U	P	V34	WU25CH	0,06	0,08	0,10	0,08	0,12	0,15	0,10	0,13	0,16	0,11	0,14	0,17
			C	V34	WU40PH												
		I	P	V34	WU40PH	0,06	0,08	0,10	0,08	0,12	0,15	0,10	0,13	0,16	0,11	0,14	0,17
			C	V34	WU40PH												
	3	S	P	V34	WPK10CH	0,08	0,11	0,15	0,10	0,12	0,16	0,11	0,14	0,18	0,12	0,15	0,20
			C	V34	WU40PH												
		U	P	V34	WU25CH	0,08	0,11	0,14	0,10	0,12	0,15	0,11	0,14	0,16	0,12	0,15	0,18
			C	V34	WU40PH												
		I	P	V34	WU40PH	0,08	0,11	0,14	0,10	0,12	0,15	0,11	0,14	0,16	0,12	0,15	0,18
			C	V34	WU40PH												
	4	S	P	V34	WPK10CH	0,08	0,11	0,15	0,10	0,12	0,16	0,11	0,14	0,18	0,12	0,15	0,20
			C	V34	WU40PH												
		U	P	V34	WU25CH	0,08	0,11	0,14	0,10	0,12	0,15	0,11	0,14	0,16	0,12	0,15	0,18
			C	V34	WU40PH												
		I	P	V34	WU40PH	0,08	0,11	0,14	0,10	0,12	0,15	0,11	0,14	0,16	0,12	0,15	0,18
			C	V34	WU40PH												
5	S	P	V36	WU25CH	0,06	0,08	0,10	0,08	0,10	0,14	0,10	0,12	0,15	0,11	0,13	0,16	
		C	V36	WU40PH													
	U	P	V36	WU40PH	0,06	0,08	0,10	0,08	0,10	0,14	0,10	0,12	0,15	0,11	0,13	0,16	
		C	V36	WU40PH													
	I	P	V36	WU40PH	0,06	0,08	0,10	0,08	0,10	0,14	0,10	0,12	0,15	0,11	0,13	0,16	
		C	V36	WU40PH													
6	S	P	V36	WU25CH	0,06	0,08	0,10	0,08	0,10	0,14	0,10	0,12	0,15	0,11	0,13	0,16	
		C	V36	WU40PH													
	U	P	V36	WU40PH	0,06	0,08	0,10	0,08	0,10	0,14	0,10	0,12	0,15	0,11	0,13	0,16	
		C	V36	WU40PH													
	I	P	V36	WU40PH	0,06	0,08	0,10	0,08	0,10	0,14	0,10	0,12	0,15	0,11	0,13	0,16	
		C	V36	WU40PH													

NOTE: For 4 x D, it is highly recommended to start with feed and speed values reduced by 10% less than above recommendations.
 For 5 x D, diameter range 12–23,99mm (insert sizes A to C), it is highly recommended to start with feed and speed values reduced by 20% less than above recommendations.
 For 5 x D, diameter range 24–68mm (insert sizes D to H), it is highly recommended to start with feed and speed values reduced by 15% less than above recommendations.
 For 4 x D and 5 x D, it is recommended to reduce the feed rate during entry and exit by 30–50%.

■ Top Cut 4 • Steel • 2 x D/3 x D • Speed Chart • Metric

Top Cut 4					Recommended Cutting Speed by Diameter (m/min)												
					Insert Size A			Insert Size B			Insert Size C			Insert Size D			
					TCF040203AC TCF040204AP 12,00–13,99mm			TCF060203BC TCF050204BP 14,00–18,99mm			TCF070304CC TCF070306CP 19,00–23,99mm			TCF090305DC TCF080308DP 24,00–29,99mm			
Material Group	Condition	Pocket Seat	Geometry	Grade	min	Start	max	min	Start	max	min	Start	max	min	Start	max	
P	1	S	P	V36	WU25CH	120	140	160	140	160	240	150	180	260	160	180	260
			C	V36	WU40PH												
		U	P	V36	WU40PH	110	120	140	130	150	220	130	170	250	140	170	250
			C	V36	WU40PH												
		I	P	V36	WU40PH	90	100	120	130	150	210	130	170	240	140	170	240
			C	V36	WU40PH												
	2	S	P	V34	WPK10CH	120	140	160	140	170	260	150	190	280	160	190	280
			C	V34	WU40PH												
		U	P	V34	WU25CH	110	120	140	130	170	240	140	180	260	150	180	260
			C	V34	WU40PH												
		I	P	V34	WU40PH	90	100	120	130	170	230	130	170	240	140	170	240
			C	V34	WU40PH												
	3	S	P	V34	WPK10CH	120	140	180	140	170	270	150	200	290	160	200	310
			C	V34	WU40PH												
		U	P	V34	WU25CH	110	120	160	130	160	260	140	200	280	150	200	280
			C	V34	WU40PH												
		I	P	V34	WU40PH	100	110	140	120	150	250	130	180	260	140	180	260
			C	V34	WU40PH												
	4	S	P	V34	WPK10CH	120	140	180	140	170	270	150	200	290	160	200	310
			C	V34	WU40PH												
		U	P	V34	WU25CH	110	120	160	130	160	260	140	200	280	150	200	280
			C	V34	WU40PH												
		I	P	V34	WU40PH	100	110	140	120	150	250	130	180	260	140	180	260
			C	V34	WU40PH												
5	S	P	V36	WU25CH	120	140	160	140	170	240	150	180	250	160	180	250	
		C	V36	WU40PH													
	U	P	V36	WU40PH	110	120	140	130	160	230	140	170	240	150	170	240	
		C	V36	WU40PH													
	I	P	V36	WU40PH	90	100	120	130	160	230	130	160	220	140	160	220	
		C	V36	WU40PH													
6	S	P	V36	WU25CH	120	140	160	140	170	200	140	170	210	150	170	210	
		C	V36	WU40PH													
	U	P	V36	WU40PH	110	120	140	120	150	190	130	160	200	140	160	200	
		C	V36	WU40PH													
	I	P	V36	WU40PH	90	100	120	110	130	180	120	140	190	120	140	190	
		C	V36	WU40PH													

NOTE: For 4 x D, it is highly recommended to start with feed and speed values reduced by 10% less than above recommendations.
 For 5 x D, diameter range 12–23,99mm (insert sizes A to C), it is highly recommended to start with feed and speed values reduced by 20% less than above recommendations.
 For 5 x D, diameter range 24–68mm (insert sizes D to H), it is highly recommended to start with feed and speed values reduced by 15% less than above recommendations.
 For 4 x D and 5 x D, it is recommended to reduce the feed rate during entry and exit by 30–50%.

■ Top Cut 4 • Steel • 2 x D/3 x D • Speed Chart • Metric

Top Cut 4					Recommended Cutting Speed by Diameter (m/min)													
					Insert Size E			Insert Size F			Insert Size G			Insert Size H				
					TCF120405EC TCF100408EP 30,00–36,99mm			TCF150406FC TCF120412FP 37,00–45,99mm			TCF180508GC TCF150512GP 46,00–56,99mm			TCF210608HC TCF180614HP 57,00–68,00mm				
Material Group	Condition	Pocket Seat	Geometry	Grade	min	Start	max	min	Start	max	min	Start	max	min	Start	max		
P	1	S	P	V36	WU25CH	160	180	260	160	180	260	160	180	260	160	180	260	
			C	V36	WU40PH													
		U	P	V36	WU40PH	140	170	250	140	170	250	140	170	250	140	170	250	
			C	V36	WU40PH													
		I	P	V36	WU40PH	140	170	240	140	170	240	140	170	240	140	170	240	
			C	V36	WU40PH													
	2	S	P	V34	WPK10CH	160	190	280	160	190	280	160	190	280	160	190	280	
			C	V34	WU40PH													
		U	P	V34	WU25CH	150	180	260	150	180	260	150	180	260	150	180	260	
			C	V34	WU40PH													
		I	P	V34	WU40PH	140	170	240	140	170	240	140	170	240	140	170	240	
			C	V34	WU40PH													
	3	S	P	V34	WPK10CH	160	200	310	160	200	310	160	200	310	160	200	310	
			C	V34	WU40PH													
		U	P	V34	WU25CH	150	200	280	150	200	280	150	200	280	150	200	280	
			C	V34	WU40PH													
		I	P	V34	WU40PH	140	180	260	140	180	260	140	180	260	140	180	260	
			C	V34	WU40PH													
	4	S	P	V34	WPK10CH	160	200	310	160	200	310	160	200	310	160	200	310	
			C	V34	WU40PH													
		U	P	V34	WU25CH	150	200	280	150	200	280	150	200	280	150	200	280	
			C	V34	WU40PH													
		I	P	V34	WU40PH	140	180	260	140	180	260	140	180	260	140	180	260	
			C	V34	WU40PH													
5	S	P	V36	WU25CH	160	180	250	160	180	250	160	180	250	160	180	250		
		C	V36	WU40PH														
	U	P	V36	WU40PH	150	170	240	150	170	240	150	170	240	150	170	240		
		C	V36	WU40PH														
	I	P	V36	WU40PH	140	160	220	140	160	220	140	160	220	140	160	220		
		C	V36	WU40PH														
6	S	P	V36	WU25CH	150	170	210	150	170	210	150	170	210	150	170	210		
		C	V36	WU40PH														
	U	P	V36	WU40PH	140	160	200	140	160	200	140	160	200	140	160	200		
		C	V36	WU40PH														
	I	P	V36	WU40PH	120	140	190	120	140	190	120	140	190	120	140	190		
		C	V36	WU40PH														

NOTE: For 4 x D, it is highly recommended to start with feed and speed values reduced by 10% less than above recommendations.
 For 5 x D, diameter range 12–23,99mm (insert sizes A to C), it is highly recommended to start with feed and speed values reduced by 20% less than above recommendations.
 For 5 x D, diameter range 24–68mm (insert sizes D to H), it is highly recommended to start with feed and speed values reduced by 15% less than above recommendations.
 For 4 x D and 5 x D, it is recommended to reduce the feed rate during entry and exit by 30–50%.

■ Top Cut 4 • Stainless Steel • 2 x D/3 x D • Feed Chart • Metric

Top Cut 4					Recommended Feed Rate by Diameter (mm/r)												
					Insert Size A			Insert Size B			Insert Size C			Insert Size D			
					TCF040203AC TCF040204AP 12,00–13,99mm			TCF060203BC TCF050204BP 14,00–18,99mm			TCF070304CC TCF070306CP 19,00–23,99mm			TCF090305DC TCF080308DP 24,00–29,99mm			
Material Group	Condition	Pocket Seat	Geometry	Grade	min	Start	max	min	Start	max	min	Start	max	min	Start	max	
M	1	S	P	V36	WU25CH	0,06	0,08	0,12	0,07	0,10	0,13	0,08	0,10	0,15	0,10	0,12	0,16
			C	V36	WU40PH												
		U	P	V36	WU40PH	0,06	0,08	0,12	0,07	0,10	0,12	0,08	0,10	0,14	0,10	0,12	0,15
			C	V36	WU40PH												
		I	P	V36	WU40PH	0,06	0,08	0,11	0,07	0,10	0,11	0,08	0,10	0,14	0,10	0,12	0,15
			C	V36	WU40PH												
	2	S	P	V36	WU25CH	0,06	0,08	0,12	0,07	0,10	0,13	0,08	0,10	0,15	0,10	0,12	0,16
			C	V36	WU40PH												
		U	P	V36	WU40PH	0,06	0,08	0,12	0,07	0,10	0,12	0,08	0,10	0,14	0,10	0,12	0,15
			C	V36	WU40PH												
		I	P	V36	WU40PH	0,06	0,08	0,11	0,07	0,10	0,11	0,08	0,10	0,14	0,10	0,12	0,15
			C	V36	WU40PH												
3	S	P	V36	WU25CH	0,06	0,08	0,12	0,07	0,10	0,13	0,08	0,10	0,15	0,10	0,12	0,16	
		C	V36	WU40PH													
	U	P	V36	WU40PH	0,06	0,08	0,12	0,07	0,10	0,12	0,08	0,10	0,14	0,10	0,12	0,15	
		C	V36	WU40PH													
	I	P	V36	WU40PH	0,06	0,08	0,11	0,07	0,10	0,11	0,08	0,10	0,14	0,10	0,12	0,15	
		C	V36	WU40PH													

NOTE: For 4 x D, it is highly recommended to start with feed and speed values reduced by 10% less than above recommendations.
 For 5 x D, diameter range 12–23,99mm (insert sizes A to C), it is highly recommended to start with feed and speed values reduced by 20% less than above recommendations.
 For 5 x D, diameter range 24–68mm (insert sizes D to H), it is highly recommended to start with feed and speed values reduced by 15% less than above recommendations.
 For 4 x D and 5 x D, it is recommended to reduce the feed rate during entry and exit by 30–50%.

■ Top Cut 4 • Stainless Steel • 2 x D/3 x D • Feed Chart • Metric

Top Cut 4					Recommended Feed Rate by Diameter (mm/r)												
					Insert Size E			Insert Size F			Insert Size G			Insert Size H			
					TCF120405EC TCF100408EP 30,00–36,99mm			TCF150406FC TCF120412FP 37,00–45,99mm			TCF180508GC TCF150512GP 46,00–56,99mm			TCF210608HC TCF180614HP 57,00–68,00mm			
Material Group	Condition	Pocket Seat	Geometry	Grade	min	Start	max	min	Start	max	min	Start	max	min	Start	max	
M	1	S	P	V36	WU25CH	0,12	0,14	0,20	0,14	0,16	0,25	0,16	0,18	0,28	0,16	0,20	0,30
			C	V36	WU40PH												
		U	P	V36	WU40PH	0,11	0,13	0,18	0,12	0,14	0,22	0,14	0,16	0,25	0,14	0,18	0,26
			C	V36	WU40PH												
		I	P	V36	WU40PH	0,11	0,13	0,18	0,12	0,14	0,22	0,14	0,16	0,25	0,14	0,18	0,26
			C	V36	WU40PH												
	2	S	P	V36	WU25CH	0,12	0,14	0,20	0,14	0,16	0,25	0,16	0,18	0,28	0,16	0,20	0,30
			C	V36	WU40PH												
		U	P	V36	WU40PH	0,11	0,13	0,18	0,12	0,14	0,22	0,14	0,16	0,25	0,14	0,18	0,26
			C	V36	WU40PH												
		I	P	V36	WU40PH	0,11	0,13	0,18	0,12	0,14	0,22	0,14	0,16	0,25	0,14	0,18	0,26
			C	V36	WU40PH												
	3	S	P	V36	WU25CH	0,12	0,14	0,20	0,14	0,16	0,25	0,16	0,18	0,28	0,16	0,20	0,30
			C	V36	WU40PH												
		U	P	V36	WU40PH	0,11	0,13	0,18	0,12	0,14	0,22	0,14	0,16	0,25	0,14	0,18	0,26
			C	V36	WU40PH												
		I	P	V36	WU40PH	0,11	0,13	0,18	0,12	0,14	0,22	0,14	0,16	0,25	0,14	0,18	0,26
			C	V36	WU40PH												

NOTE: For 4 x D, it is highly recommended to start with feed and speed values reduced by 10% less than above recommendations.
 For 5 x D, diameter range 12–23,99mm (insert sizes A to C), it is highly recommended to start with feed and speed values reduced by 20% less than above recommendations.
 For 5 x D, diameter range 24–68mm (insert sizes D to H), it is highly recommended to start with feed and speed values reduced by 15% less than above recommendations.
 For 4 x D and 5 x D, it is recommended to reduce the feed rate during entry and exit by 30–50%.

■ Top Cut 4 • Stainless Steel • 2 x D/3 x D • Speed Chart • Metric

Top Cut 4					Recommended Cutting Speed by Diameter (m/min)												
					Insert Size A			Insert Size B			Insert Size C			Insert Size D			
					TCF040203AC TCF040204AP 12,00–13,99mm			TCF060203BC TCF050204BP 14,00–18,99mm			TCF070304CC TCF070306CP 19,00–23,99mm			TCF090305DC TCF080308DP 24,00–29,99mm			
Material Group	Condition	Pocket Seat	Geometry	Grade	min	Start	max	min	Start	max	min	Start	max	min	Start	max	
M	1	S	P	V36	WU25CH	120	140	160	140	160	230	150	170	240	150	170	240
			C	V36	WU40PH												
		U	P	V36	WU40PH	110	120	140	130	150	210	130	160	210	130	160	210
			C	V36	WU40PH												
		I	P	V36	WU40PH	90	100	120	130	150	200	130	160	200	130	160	200
			C	V36	WU40PH												
	2	S	P	V36	WU25CH	120	140	160	140	160	200	150	170	210	150	170	210
			C	V36	WU40PH												
		U	P	V36	WU40PH	110	120	140	130	150	180	130	160	200	130	160	200
			C	V36	WU40PH												
		I	P	V36	WU40PH	90	100	120	120	140	170	130	150	180	130	150	180
			C	V36	WU40PH												
	3	S	P	V36	WU25CH	110	120	140	130	150	180	140	160	200	140	160	200
			C	V36	WU40PH												
		U	P	V36	WU40PH	90	110	120	120	130	160	130	140	180	130	140	180
			C	V36	WU40PH												
		I	P	V36	WU40PH	80	100	110	100	120	150	110	130	160	110	130	160
			C	V36	WU40PH												

NOTE: For 4 x D, it is highly recommended to start with feed and speed values reduced by 10% less than above recommendations.
 For 5 x D, diameter range 12–23,99mm (insert sizes A to C), it is highly recommended to start with feed and speed values reduced by 20% less than above recommendations.
 For 5 x D, diameter range 24–68mm (insert sizes D to H), it is highly recommended to start with feed and speed values reduced by 15% less than above recommendations.
 For 4 x D and 5 x D, it is recommended to reduce the feed rate during entry and exit by 30–50%.

■ Top Cut 4 • Stainless Steel • 2 x D/3 x D • Speed Chart • Metric

Top Cut 4					Recommended Cutting Speed by Diameter (m/min)												
					Insert Size E			Insert Size F			Insert Size G			Insert Size H			
					TCF120405EC TCF100408EP 30,00–36,99mm			TCF150406FC TCF120412FP 37,00–45,99mm			TCF180508GC TCF150512GP 46,00–56,99mm			TCF210608HC TCF180614HP 57,00–68,00mm			
Material Group	Condition	Pocket Seat	Geometry	Grade	min	Start	max	min	Start	max	min	Start	max	min	Start	max	
M	1	S	P	V36	WU25CH	150	170	240	150	170	240	150	170	240	150	170	240
			C	V36	WU40PH												
		U	P	V36	WU40PH	130	160	210	130	160	210	130	160	210	130	160	210
			C	V36	WU40PH												
		I	P	V36	WU40PH	130	160	200	130	160	200	130	160	200	130	160	200
			C	V36	WU40PH												
	2	S	P	V36	WU25CH	150	170	210	150	170	210	150	170	210	150	170	210
			C	V36	WU40PH												
		U	P	V36	WU40PH	130	160	200	130	160	200	130	160	200	130	160	200
			C	V36	WU40PH												
		I	P	V36	WU40PH	130	150	180	130	150	180	130	150	180	130	150	180
			C	V36	WU40PH												
	3	S	P	V36	WU25CH	140	160	200	140	160	200	140	160	200	140	160	200
			C	V36	WU40PH												
		U	P	V36	WU40PH	130	140	180	130	140	180	130	140	180	130	140	180
			C	V36	WU40PH												
		I	P	V36	WU40PH	110	130	160	110	130	160	110	130	160	110	130	160
			C	V36	WU40PH												

NOTE: For 4 x D, it is highly recommended to start with feed and speed values reduced by 10% less than above recommendations.
 For 5 x D, diameter range 12–23,99mm (insert sizes A to C), it is highly recommended to start with feed and speed values reduced by 20% less than above recommendations.
 For 5 x D, diameter range 24–68mm (insert sizes D to H), it is highly recommended to start with feed and speed values reduced by 15% less than above recommendations.
 For 4 x D and 5 x D, it is recommended to reduce the feed rate during entry and exit by 30–50%.

■ Top Cut 4 • Cast Iron • 2 x D/3 x D • Feed Chart • Metric

Top Cut 4					Recommended Feed Rate by Diameter (mm/r)												
					Insert Size A			Insert Size B			Insert Size C			Insert Size D			
					TCF040203AC TCF040204AP 12,00–13,99mm			TCF060203BC TCF050204BP 14,00–18,99mm			TCF070304CC TCF070306CP 19,00–23,99mm			TCF090305DC TCF080308DP 24,00–29,99mm			
Material Group	Condition	Pocket Seat	Geometry	Grade	min	Start	max	min	Start	max	min	Start	max	min	Start	max	
K	1	S	P	V34	WPK10CH	0,08	0,10	0,14	0,08	0,10	0,16	0,10	0,13	0,18	0,12	0,16	0,24
			C	V34	WU25CH												
		U	P	V34	WU25CH	0,08	0,10	0,14	0,08	0,10	0,16	0,10	0,13	0,18	0,12	0,16	0,24
			C	V34	WU40PH												
		I	P	V34	WU40PH	0,08	0,10	0,14	0,08	0,10	0,16	0,10	0,13	0,18	0,12	0,16	0,24
			C	V34	WU40PH												
	2	S	P	V34	WPK10CH	0,08	0,10	0,14	0,08	0,10	0,16	0,10	0,13	0,18	0,12	0,16	0,24
			C	V34	WU25CH												
		U	P	V34	WU25CH	0,08	0,10	0,14	0,08	0,10	0,16	0,10	0,13	0,18	0,12	0,16	0,24
			C	V34	WU40PH												
		I	P	V34	WU40PH	0,08	0,10	0,14	0,08	0,10	0,16	0,10	0,13	0,18	0,12	0,16	0,24
			C	V34	WU40PH												
3	S	P	V34	WPK10CH	0,08	0,10	0,14	0,08	0,10	0,16	0,10	0,13	0,18	0,12	0,16	0,24	
		C	V34	WU25CH													
	U	P	V34	WU25CH	0,08	0,10	0,14	0,08	0,10	0,16	0,10	0,13	0,18	0,12	0,16	0,24	
		C	V34	WU40PH													
	I	P	V34	WU40PH	0,08	0,10	0,14	0,08	0,10	0,16	0,10	0,13	0,18	0,12	0,16	0,24	
		C	V34	WU40PH													

NOTE: For 4 x D, it is highly recommended to start with feed and speed values reduced by 10% less than above recommendations.
 For 5 x D, diameter range 12–23,99mm (insert sizes A to C), it is highly recommended to start with feed and speed values reduced by 20% less than above recommendations.
 For 5 x D, diameter range 24–68mm (insert sizes D to H), it is highly recommended to start with feed and speed values reduced by 15% less than above recommendations.
 For 4 x D and 5 x D, it is recommended to reduce the feed rate during entry and exit by 30–50%.

■ Top Cut 4 • Cast Iron • 2 x D/3 x D • Feed Chart • Metric

Top Cut 4					Recommended Feed Rate by Diameter (mm/r)												
					Insert Size E			Insert Size F			Insert Size G			Insert Size H			
					TCF120405EC TCF100408EP 30,00–36,99mm			TCF150406FC TCF120412FP 37,00–45,99mm			TCF180508GC TCF150512GP 46,00–56,99mm			TCF210608HC TCF180614HP 57,00–68,00mm			
Material Group	Condition	Pocket Seat	Geometry	Grade	min	Start	max	min	Start	max	min	Start	max	min	Start	max	
K	1	S	P	V34	WPK10CH	0,14	0,16	0,26	0,16	0,20	0,3	0,18	0,22	0,32	0,20	0,24	0,36
			C	V34	WU25CH												
		U	P	V34	WU25CH	0,14	0,16	0,26	0,16	0,20	0,3	0,18	0,22	0,32	0,20	0,24	0,36
			C	V34	WU40PH												
		I	P	V34	WU40PH	0,14	0,16	0,26	0,16	0,20	0,3	0,18	0,22	0,32	0,20	0,24	0,36
			C	V34	WU40PH												
	2	S	P	V34	WPK10CH	0,14	0,16	0,26	0,16	0,20	0,3	0,18	0,22	0,32	0,20	0,24	0,36
			C	V34	WU25CH												
		U	P	V34	WU25CH	0,14	0,16	0,26	0,16	0,20	0,3	0,18	0,22	0,32	0,20	0,24	0,36
			C	V34	WU40PH												
		I	P	V34	WU40PH	0,14	0,16	0,26	0,16	0,20	0,3	0,18	0,22	0,32	0,20	0,24	0,36
			C	V34	WU40PH												
	3	S	P	V34	WPK10CH	0,14	0,16	0,26	0,16	0,20	0,3	0,18	0,22	0,32	0,20	0,24	0,36
			C	V34	WU25CH												
		U	P	V34	WU25CH	0,14	0,16	0,26	0,16	0,20	0,3	0,18	0,22	0,32	0,20	0,24	0,36
			C	V34	WU40PH												
		I	P	V34	WU40PH	0,14	0,16	0,26	0,16	0,20	0,3	0,18	0,22	0,32	0,20	0,24	0,36
			C	V34	WU40PH												

NOTE: For 4 x D, it is highly recommended to start with feed and speed values reduced by 10% less than above recommendations.
 For 5 x D, diameter range 12–23,99mm (insert sizes A to C), it is highly recommended to start with feed and speed values reduced by 20% less than above recommendations.
 For 5 x D, diameter range 24–68mm (insert sizes D to H), it is highly recommended to start with feed and speed values reduced by 15% less than above recommendations.
 For 4 x D and 5 x D, it is recommended to reduce the feed rate during entry and exit by 30–50%.

■ Top Cut 4 • Cast Iron • 2 x D/3 x D • Speed Chart • Metric

Top Cut 4					Recommended Cutting Speed by Diameter (m/min)												
					Insert Size A			Insert Size B			Insert Size C			Insert Size D			
					TCF040203AC TCF040204AP 12,00–13,99mm			TCF060203BC TCF050204BP 14,00–18,99mm			TCF070304CC TCF070306CP 19,00–23,99mm			TCF090305DC TCF080308DP 24,00–29,99mm			
Material Group	Condition	Pocket Seat	Geometry	Grade	min	Start	max	min	Start	max	min	Start	max	min	Start	max	
K	1	S	P	V34	WPK10CH	120	140	180	140	170	250	150	180	260	160	200	280
			C	V34	WU25CH												
		U	P	V34	WU25CH	110	120	160	130	160	240	140	170	250	150	180	260
			C	V34	WU40PH												
		I	P	V34	WU40PH	100	110	140	120	150	230	130	160	240	140	170	260
			C	V34	WU40PH												
	2	S	P	V34	WPK10CH	120	140	180	130	160	240	140	180	250	150	180	260
			C	V34	WU25CH												
		U	P	V34	WU25CH	110	120	160	120	150	230	130	160	240	140	160	250
			C	V34	WU40PH												
		I	P	V34	WU40PH	100	110	140	120	150	220	130	160	240	140	160	250
			C	V34	WU40PH												
	3	S	P	V34	WPK10CH	120	140	160	130	160	240	140	170	240	150	170	250
			C	V34	WU25CH												
		U	P	V34	WU25CH	110	120	140	120	150	230	130	160	230	140	160	240
C			V34	WU40PH													
I		P	V34	WU40PH	90	100	120	120	150	230	130	160	230	140	160	220	
		C	V34	WU40PH													

NOTE: For 4 x D, it is highly recommended to start with feed and speed values reduced by 10% less than above recommendations.
 For 5 x D, diameter range 12–23,99mm (insert sizes A to C), it is highly recommended to start with feed and speed values reduced by 20% less than above recommendations.
 For 5 x D, diameter range 24–68mm (insert sizes D to H), it is highly recommended to start with feed and speed values reduced by 15% less than above recommendations.
 For 4 x D and 5 x D, it is recommended to reduce the feed rate during entry and exit by 30–50%.

■ Top Cut 4 • Cast Iron • 2 x D/3 x D • Speed Chart • Metric

Top Cut 4					Recommended Cutting Speed by Diameter (m/min)												
					Insert Size E			Insert Size F			Insert Size G			Insert Size H			
					TCF120405EC TCF100408EP 30,00–36,99mm			TCF150406FC TCF120412FP 37,00–45,99mm			TCF180508GC TCF150512GP 46,00–56,99mm			TCF210608HC TCF180614HP 57,00–68,00mm			
Material Group	Condition	Pocket Seat	Geometry	Grade	min	Start	max	min	Start	max	min	Start	max	min	Start	max	
K	1	S	P	V34	WPK10CH	160	200	280	160	200	280	160	200	280	160	200	280
			C	V34	WU25CH												
		U	P	V34	WU25CH	150	180	260	150	180	260	150	180	260	150	180	260
			C	V34	WU40PH												
		I	P	V34	WU40PH	140	170	260	140	170	260	140	170	260	140	170	260
			C	V34	WU40PH												
	2	S	P	V34	WPK10CH	150	180	260	150	180	260	150	180	260	150	180	260
			C	V34	WU25CH												
		U	P	V34	WU25CH	140	160	250	140	160	250	140	160	250	140	160	250
			C	V34	WU40PH												
		I	P	V34	WU40PH	140	160	250	140	160	250	140	160	250	140	160	250
			C	V34	WU40PH												
	3	S	P	V34	WPK10CH	150	170	250	150	170	250	150	170	250	150	170	250
			C	V34	WU25CH												
		U	P	V34	WU25CH	140	160	240	140	160	240	140	160	240	140	160	240
			C	V34	WU40PH												
		I	P	V34	WU40PH	140	160	220	140	160	220	140	160	220	140	160	220
			C	V34	WU40PH												

NOTE: For 4 x D, it is highly recommended to start with feed and speed values reduced by 10% less than above recommendations.
 For 5 x D, diameter range 12–23,99mm (insert sizes A to C), it is highly recommended to start with feed and speed values reduced by 20% less than above recommendations.
 For 5 x D, diameter range 24–68mm (insert sizes D to H), it is highly recommended to start with feed and speed values reduced by 15% less than above recommendations.
 For 4 x D and 5 x D, it is recommended to reduce the feed rate during entry and exit by 30–50%.

■ Top Cut 4 • Drill Depth • 2 x D/3 x D

Insert size	Diameter Range (mm)	Hole Tolerance (mm)
A	12.00-13.99	+/- 0,20
B	14.00-18.99	+/- 0,20
C	19.00-23.99	+/- 0,20
D	24.00-29.99	+/- 0,20
E	30.00-36.99	+/- 0,20
F	37.00-45.99	+/- 0,25
G	46.00-56.99	+/- 0,25
H	57.00-68.00	+/- 0,28

■ Top Cut 4 • Drill Depth • 4 x D/5 x D

Insert size	Diameter Range (mm)	Hole Tolerance (mm)
A	12.00-13.99	+/- 0,35
B	14.00-18.99	+/- 0,35
C	19.00-23.99	+/- 0,35
D	24.00-29.99	+/- 0,35
E	30.00-36.99	+/- 0,35
F	37.00-45.99	+/- 0,38
G	46.00-56.99	+/- 0,38
H	57.00-68.00	+/- 0,42

■ Coolant Requirement/Recommendation

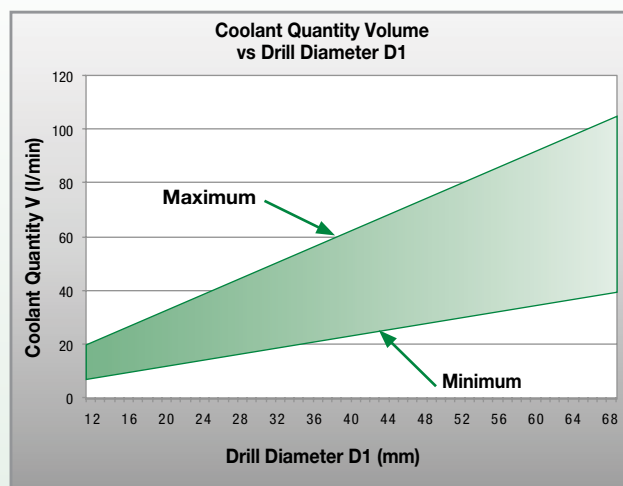

■ Power Requirement

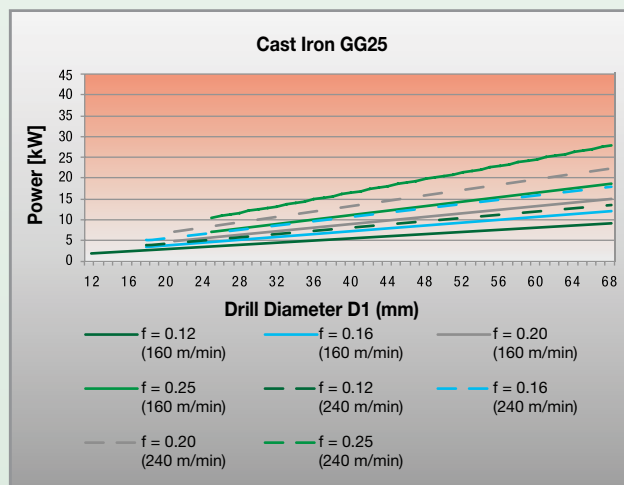
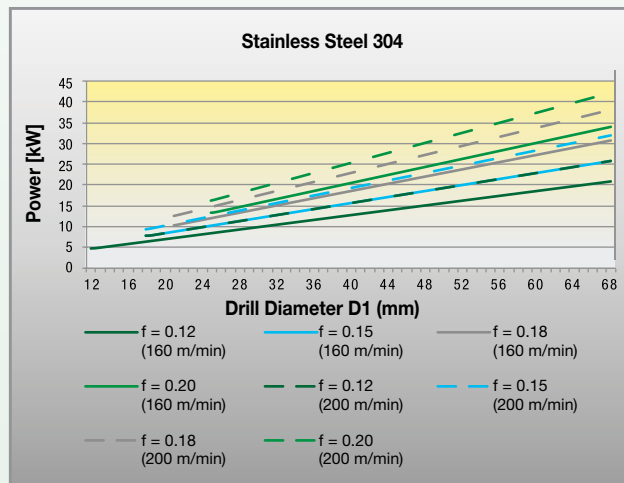
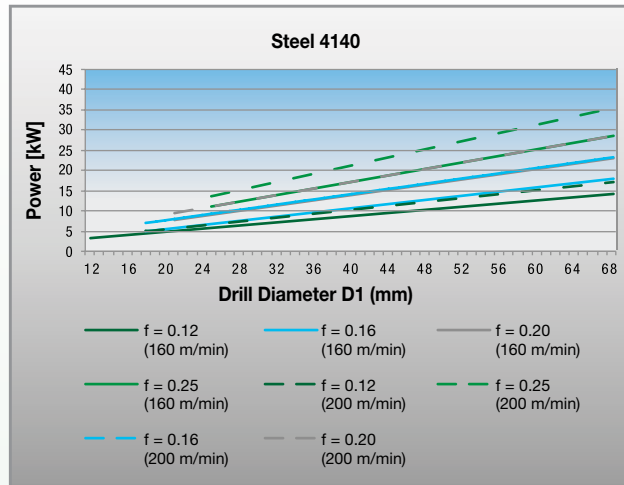

■ Feed Force Requirement

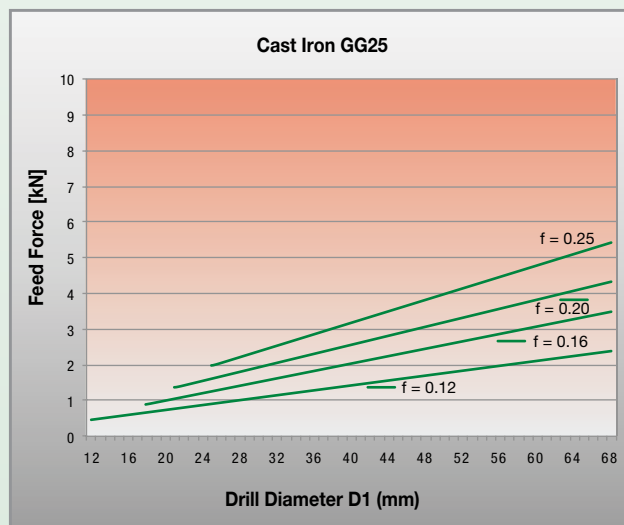
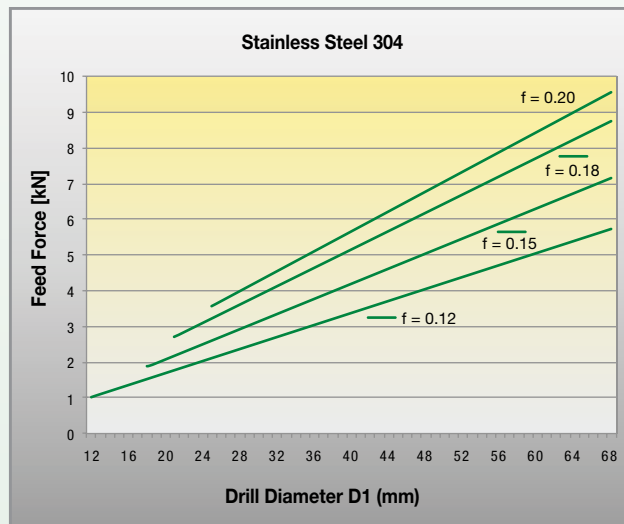
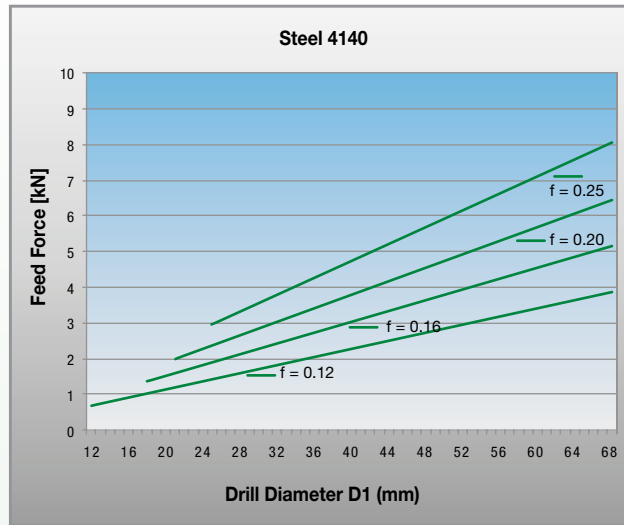

■ Torque Requirement

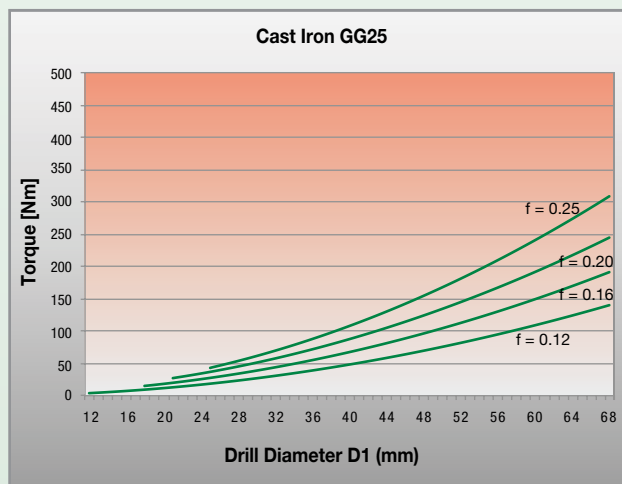
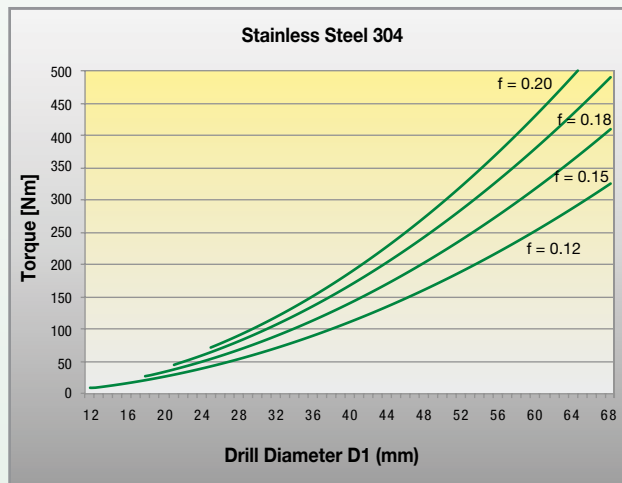
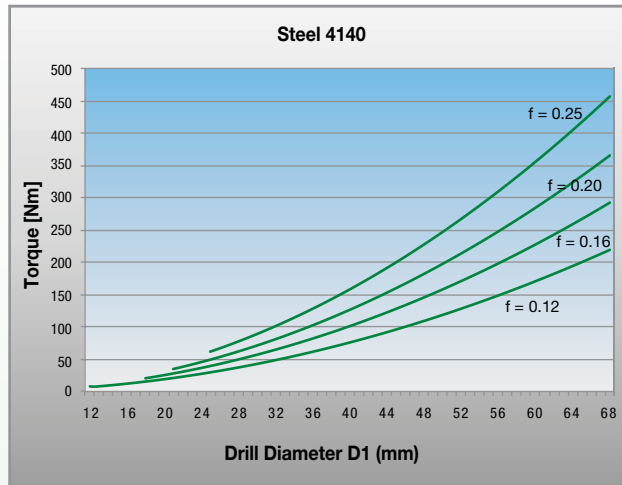

TOP CUT 4™

ADVANCES 2015

World and Corporate Headquarters

Kennametal Inc.
WIDIA Products Group
1600 Technology Way
Latrobe, PA 15650 USA
Phone: 800 446 7738 (United States and Canada)
E-mail: w-na.service@widia.com

Asia-Pacific Headquarters

Kennametal Singapore Pte. Ltd.
WIDIA Products Group
3A International Business Park
Unit #01-02/03/05, ICON@BP
Singapore 609935
Phone: +65 6265 9222
E-mail: w-sg.service@widia.com

European Headquarters

Kennametal Europe GmbH
WIDIA Products Group
Rheingoldstrasse 50
CH 8212 Neuhausen am Rheinfall
Switzerland
Phone: +41 52 6750 100
E-mail: w-ch.service@widia.com

India Headquarters

Kennametal India Limited
WIDIA Products Group
CIN: L27109KA1964PLC001546
8/9th Mile, Tumkur Road
Bangalore - 560 073
Phone: +91 080 22198444 or +91 080 43281444
E-mail: w-in.service@widia.com

©2015 Kennametal Inc. All rights reserved. A-14-04058EN_me



WWW.WIDIA.COM